



**samlex**power®

**Remote Control for  
Evolution™ Series  
Inverter/ Charger**

**Model: EVO-RC**

For use with:

(i) 120 VAC Model Nos. EVO-2212 /  
EVO-3012 / EVO-2224 / EVO-4024

(ii) 230 VAC Model Nos. EVO-2212E /  
EVO-3012E / EVO-2224E / EVO-4024E

**Owner's  
Manual**

Please read this  
manual BEFORE  
operating.

Firmware:  
Rev 0.29

<b>SECTION 1</b>	
Introduction and Layout .....	3
<b>SECTION 2</b>	
Installation .....	5
<b>SECTION 3</b>	
Operation .....	7
<b>SECTION 4</b>	
Parameter Setup .....	19
<b>SECTION 5</b>	
SD Card .....	73
<b>SECTION 6</b>	
Monitoring of Operation Using LED and Buzzer .....	81
<b>SECTION 7</b>	
Fault Messages and Troubleshooting Guide .....	82
<b>SECTION 8</b>	
Specifications .....	87
<b>SECTION 9</b>	
Warranty .....	88

## Disclaimer of Liability

UNLESS SPECIFICALLY AGREED TO IN WRITING, SAMLEX AMERICA INC.:

1. MAKES NO WARRANTY AS TO THE ACCURACY, SUFFICIENCY OR SUITABILITY OF ANY TECHNICAL OR OTHER INFORMATION PROVIDED IN ITS MANUALS OR OTHER DOCUMENTATION.
2. ASSUMES NO RESPONSIBILITY OR LIABILITY FOR LOSSES, DAMAGES, COSTS OR EXPENSES, WHETHER SPECIAL, DIRECT, INDIRECT, CONSEQUENTIAL OR INCIDENTAL, WHICH MIGHT ARISE OUT OF THE USE OF SUCH INFORMATION. THE USE OF ANY SUCH INFORMATION WILL BE ENTIRELY AT THE USERS RISK.

Samlex America reserves the right to revise this document and to periodically make changes to the content hereof without obligation or organization of such revisions or changes.

## Copyright Notice/Notice of Copyright

Copyright © 2022 by Samlex America Inc. All rights reserved. Permission to copy, distribute and/or modify this document is prohibited without express written permission by Samlex America Inc.

# SECTION 1 | Introduction and Layout

The following safety symbols will be used in this manual to highlight safety and information:



## CAUTION!

Indicates possibility of damage to the equipment in case of non-compliance.



## INFO

Indicates useful supplemental information.

## 1.0 INTRODUCTION AND LAYOUT

The EVO-RC Remote Control allows you to monitor and customize the operating parameters of Samlex Evolution™ Series Inverter/Charger Models (i) 120 VAC Model Nos. EVO-2212 / EVO-3012 / EVO-2224 / EVO-4024 and (ii) 230 VAC Model Nos. EVO-2212E / EVO-3012E / EVO-2224E / EVO-4024E.

It has its own internal Real Time Clock (*RTC*) and Super Capacitor type of battery for clock operation.

**NOTE:** This version of the manual has been adapted for use with (i)120 VAC Model Nos. EVO-2212 / EVO-3012 / EVO-2224 / EVO-4024 and (ii) 230 VAC Model Nos. EVO-2212E / EVO-3012E / EVO-3012E / EVO-2224E / EVO-4024E.

1. LCD Screen - 2 rows of 16 characters each
2. ON/OFF Key
3. Green LED "Status"
4. Red LED "Fault"
5. Navigation Key "Back"
6. Navigation Key "Up"
7. Navigation Key "Down"
8. Navigation Key "Enter"
9. SD Card Slot - FAT16/32 format; Up to 32GB
10. RJ-45 Jack (*At the back-not shown*). See pinout below:

Pin #	Signal
1	12V
2	12V
3	ON/OFF
4	D+
5	D-
6	NC
7	GND
8	GND

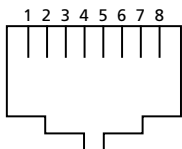

(View - Looking into the Jack)

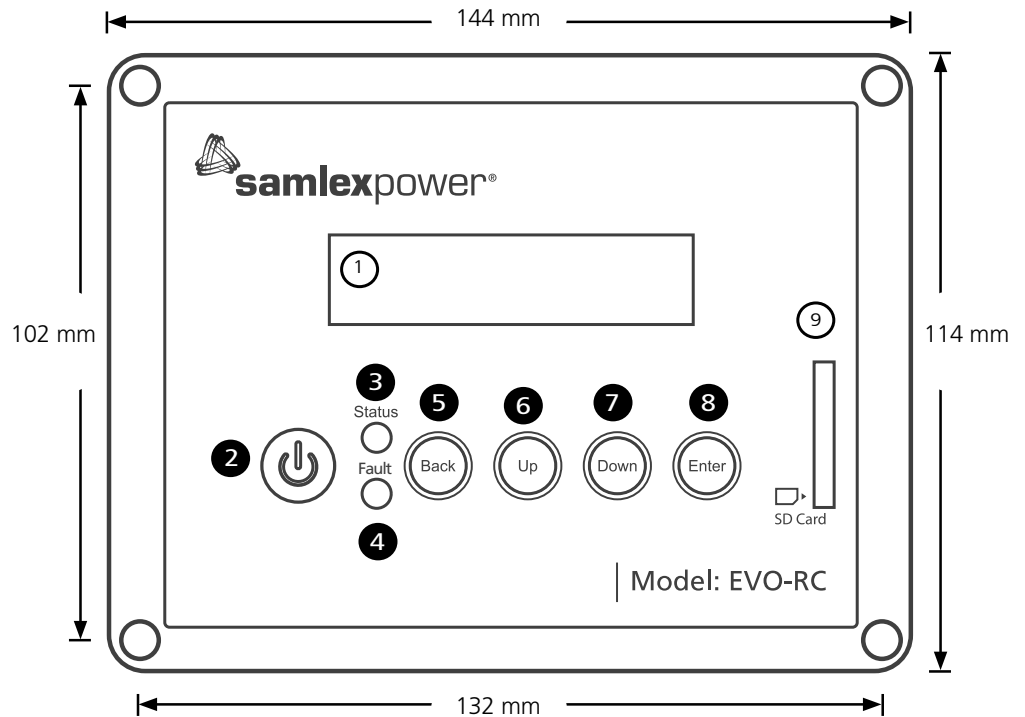

**Fig 1.1 Optional Remote Control EVO-RC - Layout & Dimensions**

# SECTION 1 | Introduction and Layout

## 1.1 LAYOUT AND DIMENSIONS

### 1.2 CONNECTING CABLE

Connecting cable shown in Fig 1.2(a) has been provided to connect the EVO-RC Remote Control to the EVO™ Inverter/ Charger Models (i) 120 VAC Model Nos. EVO-2212 / EVO-3012 / EVO-2224 / EVO-4024 and (ii) 230 VAC Model Nos. EVO-2212E / EVO-3012E / EVO-4024E. Details of the connecting cable are as follows:

- Length of cable [1, Fig 1.2(a)] : 10m / 33ft
- No. of conductors: 8
- RJ-45 (8P8C) Plugs on either end [2, Fig 1.2(a)]
- Pinouts and interconnection of the RJ-45 Plugs are shown in Fig 1.2(b)



Fig 1.2 (a) Connecting Cable

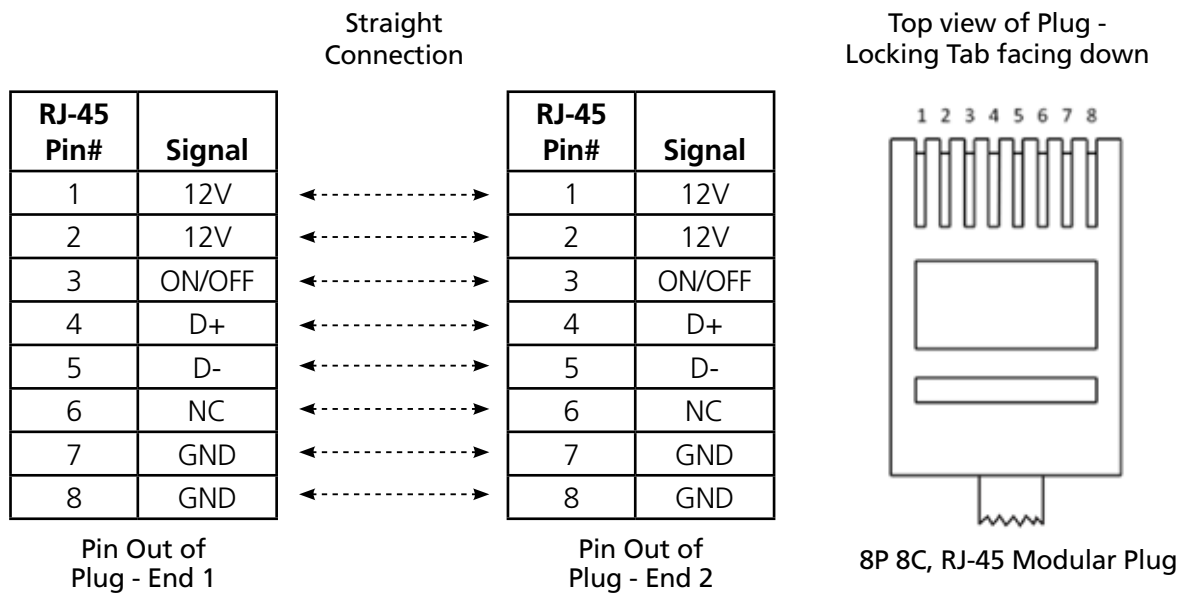

Fig 1.2 (b) Pinout and Interconnection of RJ-45 Plugs

## SECTION 2 | Installation

### 2.1 INSTALLATION GUIDELINES

The remote control is provided with 10M/33ft, Connecting Cable (*See Section 1.2*). Check the proposed routing distance of the wire and use longer wire, if necessary.

- Flush mounting of the Remote requires appropriate cut-out in the wall/panel (*Dotted line in Fig 2.1*) For this, a paper template has been provided with the unit. Take necessary precautions to ensure any wiring/plumbing running behind the wall/panel is not damaged.
- Route the wire to ensure there are no kinks.
- Use appropriate grommets when the wire is passed through holes in studs/partitions to prevent damage to insulation.

#### 2.1.2 TOOLS REQUIRED

Following tools are recommended:

- Phillips Head Screwdriver
- Knife/Saw
- Paper Template for cut-out (supplied with the unit)
- Level
- Pencil
- Hand Drill
- Drill Bit (2.5mm / #39)

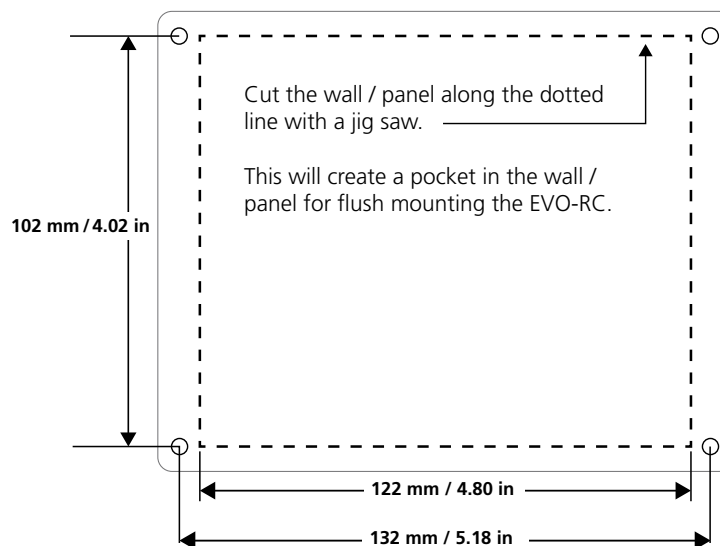

**Fig 2.1 EVO-RC Remote Cutout Dimensions for Wall/ Panel Mounting**

### 2.2 FLUSH MOUNT INSTALLATION

To flush mount, the wall opening must have at least a 2" (5 cm) depth to make room for the remote and cable. Also, the thickness of wall/panel board at the place of mounting should not be more than 13 mm to ensure that the RJ-45 jack opening is not obstructed (*see Fig. 2.3*).

11. Cut an opening in the wall using the supplied paper template (*Based on Fig 2.1*).
12. Drill four pilot holes (use 2.5mm diameter/#39 drill bit) for the 4 screws (*3mm diameter, 16mm long*) that will attach the remote to wall (*refer to Figure 2.1 for hole locations and dimensions*).
13. Route one end of the cable through wall opening to the EVO™ Inverter/Charger, and then plug it into the RJ-45 Remote Control Jack port on the EVO™ Inverter/Charger.

## SECTION 2 | Installation

14. Take the other end of remote cable and plug it into the RJ-45 Jack at the back of the EVO-RC (**Fig. 2.3**).
15. Check the remote display to ensure the Power-up self test initiates.
16. If the self test is successful, secure the EVO-RC to the wall using the four screws (**Fig 2.2**)

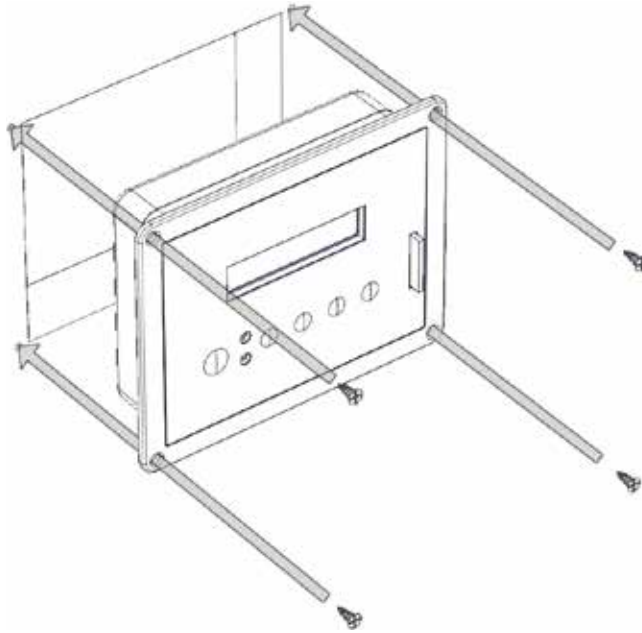

Flush mounting the EVO-RC on the wall with 4pcs,  $\Phi 3\text{mm}$  self-tapping, flat head screws (supplied with the unit).

**Fig 2.2 EVO-RC Flush Mounting**

Bottom view

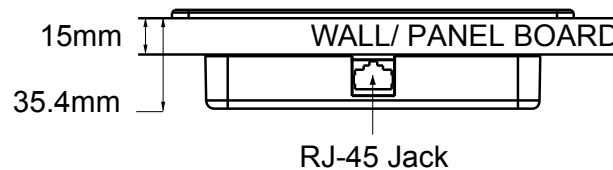

The thickness of the wall/panel board at the place of mounting should not be more than 15mm to ensure that the RJ-45 jack opening is not obstructed.

**Fig 2.3 Wall/Panel Thickness**

### 3.0 GENERAL INFORMATION

EVO-RC Remote Control provides the user with the ability to modify EVO™ Inverter/Charger's operating parameters. The default settings in EVO™ Inverter/Charger are adequate for some installations but may have to be modified for others. This Section provides details on the remote functions, status and menu maps and displays, fault messages and parameter settings.

## SECTION 3 | Operation

### 3.1 NAVIGATING THE REMOTE

The EVO-RC provides menu items and adjustable settings to configure your EVO™ Inverter/Charger to your specific parameters. Please refer to the layout at Fig 1.1.

- **LCD Display (1)** – The 2-line (*16 characters each*) LCD display with programmable backlight level shows status and information for the EVO™ Inverter/Charger. All Setup Menus and faults also appear on the LCD display.  
The level of brightness / dimming of the LCD backlight can be programmed to suit user preference. (*See Section 4.9 for details*)
- **ON/OFF Key (2)** – The ON/OFF Key is used for switching ON/switching OFF the EVO™ Inverter/Charger.
- **Navigation Keys (5, 6, 7, 8)** – These four Keys allow simple access to menu items that assists configuring, monitoring, and troubleshooting the EVO™ Inverter/Charger.
  - **Navigation Key Functions:**
    - **Back** – Return to previous selection
    - **Up** – Scroll to higher Screen Nos. / Parameter Group Nos. in various Menu Maps
    - **Down** – Scroll to lower Screen Nos. / Parameter Group Nos. in various Menu Maps
    - **Enter** – Enter the selected option
- **Status** – Green LED indicator for indicating operating status (*See details at Section 6, Table 6.1*)
- **Alarm (Fault)** – Red LED indicator for indicating fault conditions (*See details at Section 6, Table 6.1*)
- **SD Card socket** – This slot supports SD memory card (up to 32GB; FAT 16/32). The SD Card is used for (i) Data logging of EVO™ Inverter/Charger's operational statistics and events and (ii) Saving and uploading of programmed parameters (*See Section 5: SD Card*)

### 3.2 POWER ON / POWER OFF



INFO

a) Minimum battery voltage required for initiating manual switching ON of the unit is as follows:

- 12V units ----- Higher than 9V
- 24V units ---- Higher than 18V

b) Please note that this unit is designed to POWER ON AUTOMATICALLY if (i) AC voltage of  $70V \pm 5 VAC$  is available at the AC Input Terminals and (ii) DC input voltage is  $> 12V$  for 12V versions of EVO™ and  $>24V$  for 24V versions of EVO™. If the AC input voltage and frequency are within the programmed limits, the unit will automatically operate in "Charging Mode". If the AC input voltage and frequency are not within the programmed limits, the unit will operate in "Inverting" Mode. Further, as long as AC input voltage  $> 70 \pm 5 VAC$  is present, the unit CANNOT BE POWERED OFF using the ON / OFF Button on the front panel of the unit or on the Remote Control EVO-RC. Switch OFF the AC input first if the unit is required to be powered off. However, if the unit is in "Fault Mode", it will be possible to power OFF the unit with the help of the ON/OFF Push Button on the front panel of the EVO™ unit (*11, Fig 2.1 in the EVO™ Owner's Manual*) or, with the On/Off Key on the EVO-RC Remote Control (*2, Fig 1.1*)

c) Before proceeding, confirm that the unit is NOT in "Standby" Mode. If it is in "Standby Mode", the "Status" LED (*3, Fig 1.1*) will flash once every 5 sec and the LED screen will display one of the "Standby Mode" Screens show in Figs 3.2 (*Column 2, GROUP 1*). Press the On/Off Push Botton (*2, Fig 1.1*) on the EVO-RC to exit the "Standby Mode" to the current operating mode. Refer to Section 3.4 for more details on "Standby Mode".

## SECTION 3 | Operation

### 3.2.1 Power ON - AC INPUT IS NOT PRESENT

The sequence given below in Fig 3.1(a) is applicable *when there is no AC input* and the unit is switched ON.

Press On/Off Key and hold for 2 second to turn the EVO™ Inverter/Charger ON.

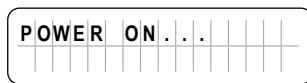

Screen (a)

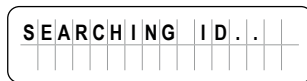

Screen (b)

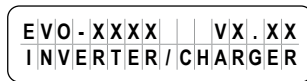

Screen (c)

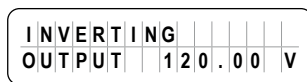

Screen (d)

When the EVO™ Inverter/Charger is OFF and the On/Off Key is pressed and held, the LCD screen shows "POWER ON..." [Screen (a)] and the Status LED flashes 3 times. On/Off Key may be released now. After 2 seconds, EVO-RC starts to search for the communication ID of the EVO™ Inverter/Charger it is attached to. The LCD screen shows "SEARCHING ID ..." [Screen (b)] and the ID number which is found is shown at the end of the line. When the default ID of "1" is found, the display will then show the EVO™ Inverter/Charger Model No. and firmware version (3 digit number X.XX) [Screen (c)]. The screen will then change to the Inverting Mode Screen [Screen (d)].

**Fig 3.1(a) Power On Sequence  
(No AC Input)**

### 3.2.2 Power OFF - AC INPUT IS NOT PRESENT

#### NOTE:

**If the EVO™ Inverter/Charger has AC input voltage over  $70 \pm 5$  VAC available at AC input terminals, the Power OFF function is disabled and the unit will remain in the ON condition if the power off sequence is attempted. The AC input must be removed before the unit can be powered OFF.**

The sequence given below in Fig 3.1(b) is applicable when the unit is required to be powered off *when no AC input is present*.

Press On/Off Key and hold for 5 seconds to turn OFF the EVO™ Inverter/Charger.

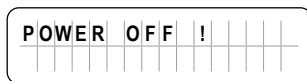

**Fig 3.1(b) Power Off Sequence  
(No AC Input)**

When EVO™ Inverter/Charger is ON and the On/Off key is pressed and held for minimum of 5 seconds, the LCD screen will show "POWER OFF !" and both the Status and Alarm/ Fault LEDs will turn ON. Now release the On/Off key (***please note that Power Off sequence will be completed and display "POWER OFF !" will disappear only when the On/Off key is released***).



## SECTION 3 | Operation

### 3.3 DATE AND TIME SETUP

Set date and time as per procedure given at Section 4.10: "Group 6 Parameter Setup: Time Setting".

### 3.4 STANDBY MODE

When the EVO™ is in Standby Mode, inverting or charging / AC pass through will be suspended.



#### INFO

Standby Mode may be used to temporarily halt normal operation of the Inverter/Charger without switching OFF the unit completely.

For the Standby Mode to be switched ON, the EVO™ should be in ON condition and should be operating in one of the 4 Operating Modes – "Inverting" or "Charging", "Power Saving" or "Online" (See Fig 3.2). When Standby Mode is switched ON, the EVO™ will suspend its Operating Mode.

#### 3.4.1 Procedure to Enter and Exit Standby Mode / Status Display in Standby Mode



#### INFO

- EVO-RC Remote Control is required to enter Standby Mode as explained in Section 3.4.1.1 below. Once Standby Mode is entered, it can **ALSO** be switched off using the On/Off Push Button on the front panel of the EVO™ Inverter/Charger Unit (See Section 3.4.1.2)
- If the EVO-RC Remote Control has **NOT** been connected to the EVO™ Inverter/Charger Unit, Standby Mode cannot be entered using the On/Off Push Button on the front panel of the EVO™ Inverter/Charger Unit

**3.4.1.1 Entering Standby Mode Using Remote Control EVO-RC:** Changing over from any Operating Mode ("Inverting", "Charging" or "Power Save") to Standby Mode can be carried out with the help of Remote-Control EVO-RC as follows:

- a) From any Operating Mode Screen ("Inverting", "Charging" or "Power Save"), press the On/Off Push Key (2, Fig 1.1) momentarily (0.1 sec)
- b) Screen 1 below will be displayed first for 1 sec followed by Screen 2 below for 1 sec. **This display sequence will be displayed 2 times and then, the screen will go back to the Operating Mode Screen.**
  - If Standby Mode is required to be activated, press the On/Off Push Key (2, Fig 1.1) momentarily (0.1 sec)
  - If Standby Mode is not required to be activated, press the Back Key (5, Fig 1.1) momentarily (0.1 sec)

Screen 1:

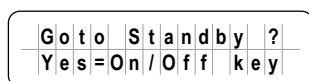

Screen 2:

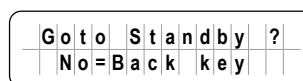

- c) On entering Standby Mode, the following will be displayed:

## SECTION 3 | Operation



- i. **On the EVO-RC:** The LCD will show the 1<sup>st</sup> screen of the 7 Standby Mode Screens (See Screens 1 to 7 of screens shown under Group 1, Standby Mode in Fig 3.2) and Status LED (3, Fig 1.1) will blink once every 5 sec
- ii. **On the Front Panel of EVO™ Inverter/Charger:** The Green LED marked "ON" (12, Fig 2.1 of the EVO™ Owner's Manual) will blink once every 5 sec. Red LED marked "FAULT" (13, Fig 2.1 of the attached EVO™ Owner's Manual) and Buzzer will be off

### 3.4.1.2 Exiting Standby Mode: Standby Mode can be exited as follows:

- Using EVO-RC: To exit Standby Mode using Remote Control EVO-RC, press the On/Off Key (2, Fig 1.1) momentarily (0.1 sec).
- From Front Panel of EVO™ Inverter/Charger: It is **NOT POSSIBLE** to exit Standby Mode by momentary pressing of the On/Off Push Button on the front panel of EVO™ (11, Fig 2.1 of the attached EVO™ Owner's Manual) if EVO-RC Remote is **NOT** connected to EVO.



#### INFO

When Standby Mode is exited, the EVO™ Inverter/Charger Unit will execute the programmed Operating Mode from the beginning. It will **NOT** start from the last condition of the operating stage it was in when Standby Mode was activated.

## 3.5. FAULT MESSAGES & CLEARING FAULTS

If any fault occurs, the LCD screen will display the Fault Message and the Red LED "Fault" will be lighted. Refer to Table 7.1 in Section 7 for details of various fault messages and procedure to clear the fault.



#### CAUTION!

The cause of the fault must be removed before the unit is restarted.



#### ATTENTION!

La cause du défaut doit être éliminée avant le redémarrage de l'unité.

## 3.6 OPERATING MODES AND ASSOCIATED LCD DISPLAY SCREENS

### 3.6.1 Menu Maps for Operating Mode Screens

When the unit is operating normally, the LCD Screen will display the name of the Operating Mode and values of various associated operating parameters. As all the operating parameters associated with a particular Operating Mode cannot be displayed in one screen, multiple screens are available that can be accessed by scrolling the screens using the Up and Down Keys. For ease of navigating through the various screens, all the screens covering a particular Operating Mode have been arranged in the associated Menu Map. Table 3.1 shows the names of the Operating Modes and the Fig Nos. of the associated Menu Maps.

## SECTION 3 | Operation

**Table 3.1 Operating Modes and Associated Menu Maps/ LCD Display Screens**

Operating Mode	Description	Section and Fig No. of Associated Menu Map
STANDBY MODE	Standby Mode: No output, No AC bypass, No Charging	Section 3.6.2 Fig 3.2
INVERTING MODE	Unit is operating as an inverter	Section 3.6.2 Fig 3.2
CHARGING MODE	Unit is operating as a battery charger and passing through the AC input to the loads	Section 3.6.2 Fig 3.2
POWER SAVING MODE	Unit is in Power Saving Mode	Section 3.6.2 Fig 3.2
ON LINE	Unit is in On Line Mode	Section 3.7 Fig 3.3(a) to 3.3(d)
CHARGER ONLY	<i>Applicable when Parameter "ONLINE MODE", Option: 2=Charger is selected.</i> Provides charging and pass through when the AC input is available. <i>No inverting when the AC input is not available.</i>	Section 3.8 Fig 3.4(a) & 3.4(b)
CHGR STOP BY BMS	<i>Applicable when Parameter "BATTERY TYPE", Option: 1=Lithium is selected.</i> This mode is activated when the Lithium Battery Management System (BMS) sends command to EVO™ ( <i>contact closure signal</i> ) to stop charging to prevent battery over voltage or over temperature.	Section 3.9 Fig 3.5
INV STOP BY BMS	<i>Applicable when Parameter "BATTERY TYPE", Option: 1=Lithium is selected.</i> This mode is activated when the Lithium Battery Management System (BMS) sends command to EVO™ ( <i>contact closure signal</i> ) to stop inverting to prevent deep discharge of the battery.	Section 3.10, Fig 3.6

### 3.6.2 Menu Map for Standby/ Inverting/ Charging/ Power Save Modes

Fig 3.2 shows Menu Map for the 4 main Operating Modes: (i) STANDBY MODE (ii) INVERTING MODE (iii) CHARGING MODE and (iv) POWER SAVING MODE.

Any screen within Menu Map in Fig 3.2 for the 4 Main Operating Modes can be identified by 2 co-ordinates: Operating Mode Group No (*Column*) and Display Screen No (*Row*).

Menu Maps/ Display Screens detailed in Table 3.2 are self-explanatory.

### 3.6.3 Charging Profile and Charging Stage information included in Charging Mode Display Screens

When the unit is operating in Charging Mode, all the relevant operating information related to this mode is displayed through 19 scrollable screens (*Screen Nos 1 to 19*) as shown in Fig 3.2 under Column 4 - "GROUP 3: CHARGING MODE"

The left corner of the 1<sup>st</sup> line of the display screen shows "CHARGING" and the right corner shows coded / abbreviated information as follows:

- a) The first character of the right-hand corner display indicates the code for the Charging Profile that is active:
  - i. Numeral 0 to 5 for 6 options for 3-Stage / 2-Stage Charging Profiles (*Refer to Section 4.4.2.21 for details*), or
  - ii. Letter "E" for 4-Stage Adaptive Profile for Equalization (*Refer to Section 4.4.2.12*)
- b) The other portion of the right-hand corner display provides the following coded information pertaining to the Charging Stage that is active:

## SECTION 3 | Operation

- **CC** for **C**onstant **C**urrent Stage
- **CV** for **C**onstant **V**oltage 2<sup>nd</sup> Stage in 3-Stage / 2-Stage Charging Profiles
- **E-CVA** for **C**onstant **V**oltage **A**bsorption Stage in 4-Stage Adaptive Charging Profile for Equalization
- **E-CVE** for **C**onstant **V**oltage **E**qualization Stage in 4-Stage Adaptive Charging Profile for Equalization
- **FLOAT** for Float Stage
- **OFF** for charger off

Consolidated information related to the 1<sup>st</sup> line right hand corner display is given in Table 3.2 below:

<b>1<sup>st</sup> line, right corner display under "GROUP 3: CHARGING MODE" screens in Fig 3.2</b>	<b>Description</b>
<b>0-CC</b>	Constant Current, Bulk Stage, Parameter CHARGING PROFILE option : 0=3Stg Adaptiv
<b>1-CC</b>	Constant Current, Bulk Stage, Parameter CHARGING PROFILE option : 1=3Stage Type1
<b>2-CC</b>	Constant Current, Bulk Stage, Parameter CHARGING PROFILE option : 2=3Stage Type2
<b>3-CC</b>	Constant Current, Bulk Stage, Parameter CHARGING PROFILE option : 3=2Stage Type1
<b>4-CC</b>	Constant Current, Bulk Stage, Parameter CHARGING PROFILE option : 4=2Stage Type2
<b>5-CC</b>	Constant Current, Bulk Stage, Parameter CHARGING PROFILE option : 5=2Stage Type3
<b>E-CC</b>	Constant Current, Bulk stage of 4-Stage Adaptive Profile for Equalization
<b>0-CV</b>	Constant Voltage, Absorption stage, Parameter CHARGING PROFILE option : 0=3Stg Adaptiv
<b>1-CV</b>	Constant Voltage, Absorption Stage, Parameter CHARGING PROFILE option : 1=3Stage Type1
<b>2-CV</b>	Constant Voltage, Absorption Stage, Parameter CHARGING PROFILE option : 2=3Stage Type2
<b>3-CV</b>	Constant Voltage, Absorption Stage, Parameter CHARGING PROFILE option : 3=2Stage Type1
<b>4-CV</b>	Constant Voltage, Absorption Stage, Parameter CHARGING PROFILE option : 4=2Stage Type2
<b>5-CV</b>	Constant Voltage, Absorption Stage, Parameter CHARGING PROFILE option : 5=2Stage Type3
<b>E-CVA</b>	Constant Voltage, Absorption Stage of 4-Stage Adaptive Profile for Equalization
<b>E-CVE</b>	Constant Voltage, Equalization Stage of 4-Stage Adaptive Profile for Equalization
<b>0-FLOAT</b>	Float Stage, Parameter CHARGING PROFILE option : 0=3Stg Adaptiv
<b>1-FLOAT</b>	Float Stage, Parameter CHARGING PROFILE option : 1=3Stage Type1
<b>2-FLOAT</b>	Float Stage, Parameter CHARGING PROFILE option : 2=3Stage Type2
<b>3-OFF</b>	Charger Off, AC bypass, Parameter CHARGING PROFILE option : 3=2Stage Type1
<b>5-OFF</b>	Charger Off, AC bypass, Parameter CHARGING PROFILE option : 5=2Stage Type3
<b>CHGR STOP BY BMS</b>	Charging switches off when Pins 4 and 5 of Battery Temperature Sensor Jack ( <i>6 in Fig 2.1 of EVO™ Owner's Manual</i> ) are shorted by control signal from Lithium Ion Battery Management System (BMS).

For example, in Fig 3.2, the 1<sup>st</sup> line of information under Column 4 (*GROUP 3: CHARGING MODE*) shows "0-CC" in the right corner. This means that the unit is charging under the following conditions:

- CHARGING PROFILE: Option "0=3Stg Adaptiv" i.e. 3-Stage Adaptive Charging Profile (*Refer to Section 5.7 of the EVO™ Owner's Manual*)
- Charging Stage: "CC" i.e. **C**onstant **C**urrent Bulk Stage

# SECTION 3 | Operation

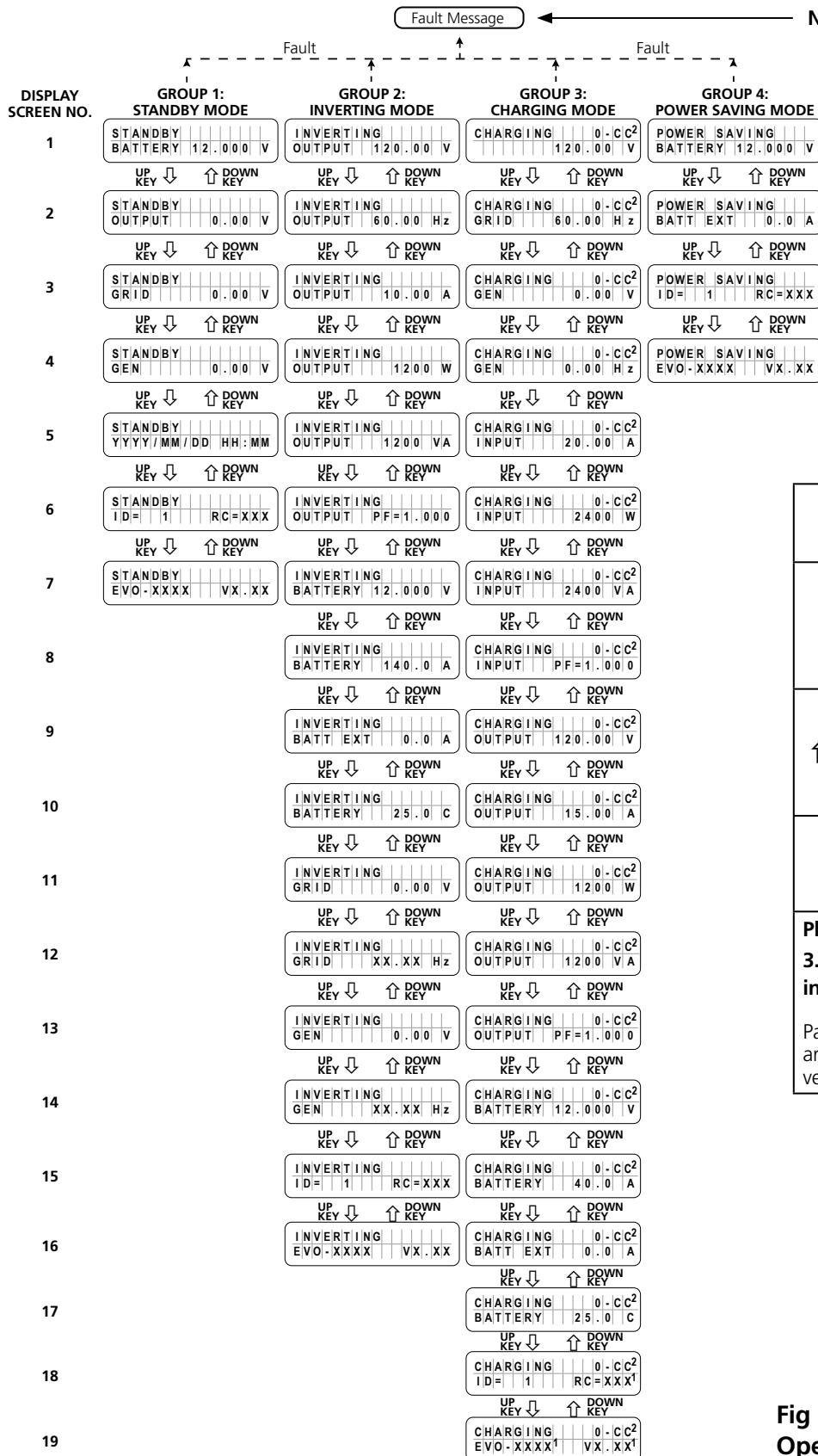

NOTE: See Table 7.1 for fault messages

LEGEND FOR FIG 3.2	
UP KEY ↓	Move downwards to higher Display Screen No. (See Note 3 under "NOTES FOR FIG 3.2" on Page 14)
↑ DOWN KEY	Move upwards to lower Display Screen No. (See Note 3 under "NOTES FOR FIG 3.2" on Page 14)
1,2	Refer to Notes 1 & 2 under "NOTES FOR FIG 3.2" on Page 14
Please Refer to "NOTES FOR FIG 3.2" on Page 14 for additional information related to this FIG 3.2	
Parameter values shown in the screens are the default values for the 12V versions i.e. EVO-2212/3012.	

Fig 3.2 Menu Map For Overall Operating Mode Display Screens

## SECTION 3 | Operation

### NOTES FOR FIG 3.2:

- The 3-digit No. XXX in "RC-XXX" indicates the Firmware Revision No. for the Remote Control EVO-RC
  - The 4-digit No. XX.X in EVO-VX.XX denotes the Firmware Revision No. for the EVO™ Inverter/Charger
  - The 4-digit No. XXXX in EVO-XXXX denotes the Model No. of Evolution™ Series Inverter/Charger i.e. EVO-2212 / 2224 / 3012 / 4024
- The display on the top right corner of the 19 Display Screens (*Display Screen Nos. 1 to 19*) under "CHARGING" Mode (*Column 4, Group 3*) indicates the Charging Profile & the Charging Stage. *Refer to Section 3.6.3 & Table 3.2 for details.*
- The following convention has been used to show up and down scrolling of the screens:

<b>UP KEY</b> ↓	Press Up Key to scroll to the next screen in the downward direction towards higher Screen Nos
↑ <b>DOWN KEY</b>	Press Down Key to scroll to the previous screen in the upward direction towards lower Screen Nos
- See Section 3.7 for information on Operating Mode Display Screens when the unit is in On-Line Mode
- Parameter values shown in the screens are the default values for the 12V versions i.e. EVO-2212/3012.

### 3.7 MENU MAPS FOR ON-LINE MODE SCREENS



#### INFO

Please refer to the following for additional information on "On-Line Mode":

- Section 4.8.5.2 of the EVO™ Owner's Manual for a description and application of "On-Line Mode"
- Section 4.4.2.13.2 for selecting programming option "1=On-Line" for On-Line Mode under programming Parameter "MODE" (*Section 4.4.2.13*)

On-Line Mode Screens will be similar to the Off-line Mode Screens shown in Fig 3.2 for Menu Map for Overall Operating Mode Screens. Each On-Line Mode Screen will show "ONLINE" in the right corner of the first line of the screen. Each screen will alternate every 2 sec between Off-Line Mode Screen and On-Line Mode Screen. Examples of Screen 1 of each of the 4 Operating Modes is shown in Figs 3.3(a) to 3.3(d) below:

STANDBY																					
BATTERY																					

The above 2 Display Screens alternate every 2 sec

**Fig 3.3 (a) Example of Display Screen No. 1 of 7 Display Screens in Menu Map for "GROUP 1: STANDBY MODE"** (*See Column 2 of Fig 3.2*)

STANDBY																					ONLINE
BATTERY																					V

INVERTING																					ONLINE
OUTPUT																					V

The above 2 Display Screens alternate every 2 sec

**Fig 3.3 (b) Example of Display Screen No. 1 of 16 Display Screens in Menu Map for "GROUP 2: INVERTING MODE"** (*See Column 3 of Fig 3.2*)

## SECTION 3 | Operation

CHARGING				0. CC
				120.00 V

CHARGING	ONLINE			
				120.00 V

The above 2 Display Screens alternate every 2 sec

**Fig 3.3 (c) Example of Display Screen No. 1 of 19 Display Screens in Menu Map for "GROUP 3: CHARGING MODE"** (See Column 4 of Fig 3.2)

POWER SAVING				
BATTERY	12.000	V		

PWR SAVE	ONLINE			
BATTERY	12.000	V		

The above 2 Display Screens alternate every 2 sec

**Fig 3.3 (d) Example of Display Screen No. 1 of 4 Display Screens in Menu Map for "GROUP 4: POWER SAVE MODE"** (See Column 5 of Fig 3.2)

### 3.8 MENU MAP FOR "CHARGER ONLY" MODE SCREENS



#### INFO

Refer to Section 4.4.2.13.3 regarding programming option "2=CHARGER ONLY" under programming parameter "MODE" ([Section 4.4.2.13](#))

**3.8.1** When this option is selected, the EVO™ will remain in "Charging Mode" as long as qualified AC input voltage is available. During the time AC input is available, 19 scrollable Operating Mode Screens for "CHARGING MODE" will be available as per Menu Map shown in Fig 3.4(a) on page 16 (*This Menu Map is also shown in the Menu Map in Fig 3.2 at Column 4 under heading "GROUP 3, CHARGING MODE"*)

**3.8.2** In case AC input voltage fails or is switched off, EVO™ will NOT change over to "Inverting Mode" but will enter "STANDBY MODE" (**NOTE: AC side loads will lose AC power**). During the time AC input is NOT available, 7 scrollable Operating Mode Screens for STANDBY MODE will be displayed as shown in Menu Map at Fig 3.4(b) on page 16. (*Also shown in Menu Map at Fig 3.2 in Column 2 under heading "GROUP 1, STANDBY MODE"*)

**3.8.2.1** If attempt is made to exit "STANDBY MODE" by momentarily pressing the On/Off Key, message

CHARGER ONLY				
INVERTER OFF				

will be seen for some time and the screen will revert back to the "STANDBY MODE" Screen that was being displayed

# SECTION 3 | Operation

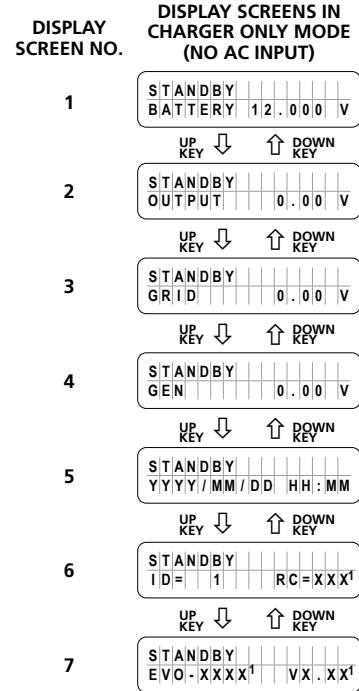
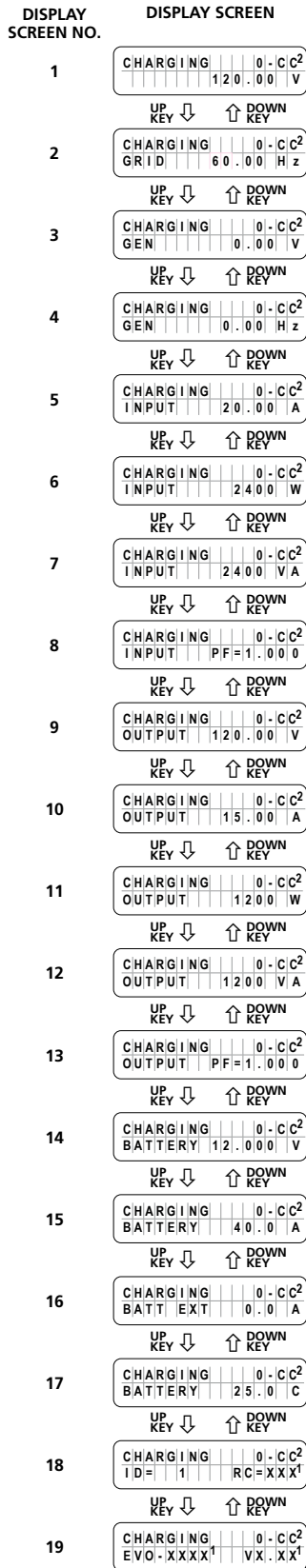

**Fig 3.4 (b) Menu Map of Operating Mode Screens in Charger Only Mode (No AC input)**

**LEGEND FOR FIGS 3.4(a) and 3.4(b):**

- The 3-digit No. XXX in "RC-XXX" indicates the Firmware Revision No. for the Remote Control EVO-RC
  - The 4-digit No. XX.X in EVO-VX.XX denotes the Firmware Revision No. for the EVO™ Inverter/Charger
  - The 4-digit No. XXXX in EVO-XXXX denotes the Model No. of Evolution™ Series Inverter/Charger  
i.e. EVO-2212 / 2224 / 3012 / 4024
- The display on the top right corner of the 19 Display Screens (*Display Screen Nos. 1 to 19*) in Fig 3.4(a) indicates the Charging Profile & the Charging Stage. *Refer to Section 3.6.3 & Table 3.2 for details.*
- The following convention has been used to show up and down scrolling of the screens:

<b>UP KEY</b> ↓	Press Up Key to scroll to the next screen in the downward direction towards higher Screen Nos
↑ <b>DOWN KEY</b>	Press Down Key to scroll to the previous screen in the upward direction towards lower Screen Nos
- Parameter values shown in the screens are the default values for the 12V versions i.e. EVO-2212/3012.

**Fig 3.4 (a) Menu Map of Operating Mode Screens in Charger Only Mode (AC input is available)**



# SECTION 3 | Operation

## 3.9 MENU MAP FOR "CHARGER STOP BY BMS" MODE SCREENS



### INFO

For background information, refer to Section 4.4.2.22.2 regarding "Stop Charging" control by Lithium Ion Battery Management System (BMS) for on/off control of charging operation of EVO™ Inverter/Charger.

When BMS activates "Stop Charging" signal (*The Drain-Source terminals of the BMS will close and short Pins 1/2/3/4 and 5/6/7/8 of RJ-45 Jack marked "Battery Temp Sensor" on the front panel of EVO™*), EVO™ will stop charging (***Internally, EVO™ will be in Charging Mode, but the charging current will be reduced to 0A***). 19 scrollable display screens will be available to show the status of various parameters as shown in the Menu Map at Fig 3.5 on the left.

**NOTE:** The 19 "CHGR STOP BY BMS" display screens shown in Fig 3.5 on the left are the same as the 19 display screens shown for Menu Map for screens for "Charging Mode" (Fig 3.2 – Column 3 under heading "GROUP 3: CHARGING MODE") **but with the 1<sup>st</sup> line replaced with "CHGR STOP BY BMS"**

DISPLAY SCREEN NO.	DISPLAY SCREEN
1	CHGR STOP BY BMS 120.00 V UP KEY ↓ DOWN KEY ↑
2	CHGR STOP BY BMS GRID 60.00 Hz UP KEY ↓ DOWN KEY ↑
3	CHGR STOP BY BMS GEN 0.00 V UP KEY ↓ DOWN KEY ↑
4	CHGR STOP BY BMS GEN 0.00 Hz UP KEY ↓ DOWN KEY ↑
5	CHGR STOP BY BMS INPUT 20.00 A UP KEY ↓ DOWN KEY ↑
6	CHGR STOP BY BMS INPUT 24.00 W UP KEY ↓ DOWN KEY ↑
7	CHGR STOP BY BMS INPUT 24.00 VA UP KEY ↓ DOWN KEY ↑
8	CHGR STOP BY BMS INPUT PF=1.000 UP KEY ↓ DOWN KEY ↑
9	CHGR STOP BY BMS OUTPUT 120.00 V UP KEY ↓ DOWN KEY ↑
10	CHGR STOP BY BMS OUTPUT 15.00 A UP KEY ↓ DOWN KEY ↑
11	CHGR STOP BY BMS OUTPUT 1200 W UP KEY ↓ DOWN KEY ↑
12	CHGR STOP BY BMS OUTPUT 1200 VA UP KEY ↓ DOWN KEY ↑
13	CHGR STOP BY BMS OUTPUT PF=1.000 UP KEY ↓ DOWN KEY ↑
14	CHGR STOP BY BMS BATTERY 12.000 V UP KEY ↓ DOWN KEY ↑
15	CHGR STOP BY BMS BATTERY 4.0.0 A UP KEY ↓ DOWN KEY ↑
16	CHGR STOP BY BMS BATT EXT 0.0 A UP KEY ↓ DOWN KEY ↑
17	CHGR STOP BY BMS BATTERY 25.0 C UP KEY ↓ DOWN KEY ↑
18	CHGR STOP BY BMS ID=1 RC=XXX UP KEY ↓ DOWN KEY ↑
19	CHGR STOP BY BMS EVO-XXX <sup>1</sup> V.X.XX <sup>1</sup> UP KEY ↓ DOWN KEY ↑

LEGEND FOR FIG 3.5	
UP KEY ↓	Press Up Key to scroll the screen in the downward direction towards higher Screen Nos
↑ DOWN KEY	Press Down Key to scroll the screen in the upward direction towards lower Screen Nos
<b>NOTE:</b> Parameter values shown in the various display screens are the default values for 12V versions i.e. EVO-2212 / EVO-3012	

**Fig 3.5 Menu Map for Display Screens during "Charger Stop by BMS"**

# SECTION 3 | Operation

## 3.10 MENU MAP FOR "INVERTER STOP BY BMS" MODE SCREENS



**INFO**

For background information, refer to Section 4.4.2.22.2 regarding "Stop Inverting" control by Lithium Ion Battery Management System (BMS) for on/off control of inverting operation of EVO™ Inverter/Charger.

When BMS activates "Stop Inverting" signal (The Drain-Source terminals of the BMS will close and short Pins 1/2/3/4 and 5/6/7/8 of RJ-45 Jack marked "Battery Temp Sensor" on the front panel of EVO), EVO™ will stop inverting (Internally, EVO™ will be in Standby Mode). 7 scrollable display screens will be available to show the status of various operating parameters as shown in the Menu Map at Fig 3.6 on the right:

**NOTE:** The 7 "INV STOP BY BMS" display screens shown in Fig 3.6 on the right are the same as the 7 display screens shown for Menu Map for "Standby Mode" (Fig 3.2 – Column 2 under heading "GROUP 1: STANDBY MODE") but with the 1<sup>st</sup> line replaced with "INV STOP BY BMS"

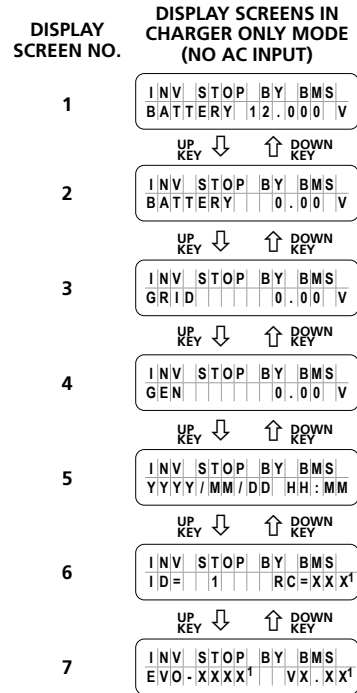

LEGEND FOR FIG 3.6	
UP KEY ↓	Press Up Key to scroll the screen in the downward direction towards higher Screen Nos
↑ DOWN KEY	Press Down Key to scroll the screen in the upward direction towards lower Screen Nos

**Fig 3.6 Menu Map for Display Screens during "Charger Stop by BMS" Mode**

## SECTION 4 | Parameter Setup

### 4.1 PARAMETER SETUP MENU MAPS

#### 4.1.1 General Information

Up to 63 operating parameters (*Figs 4.1 and 4.2*) can be programmed to suit the desired operating conditions.

The 63 programming parameters have been arranged under 7 "PARAMETER GROUPS" (*Displayed under heading "SELECT GROUP"*) as shown in Parameter Setup Menu Map for "PARAMETER GROUPS" 1 - 4 in Fig 4.1 & for "PARAMETER GROUPS" 5 - 7 in Fig 4.2.



#### INFO

Parameter Setup Menu Maps in Figs 4.1 & 4.2 have been explained using LCD screen displays with information as seen on the actual LCD screens.

- All values shown in the second row of setup screen displays are the default parameters for EVO-2212/3012/2212E/3012E.
- All voltage values related to battery voltages are the default values for 12V versions i.e. EVO-2212/3012/2212E/3012E.

# SECTION 4 | Parameter Setup

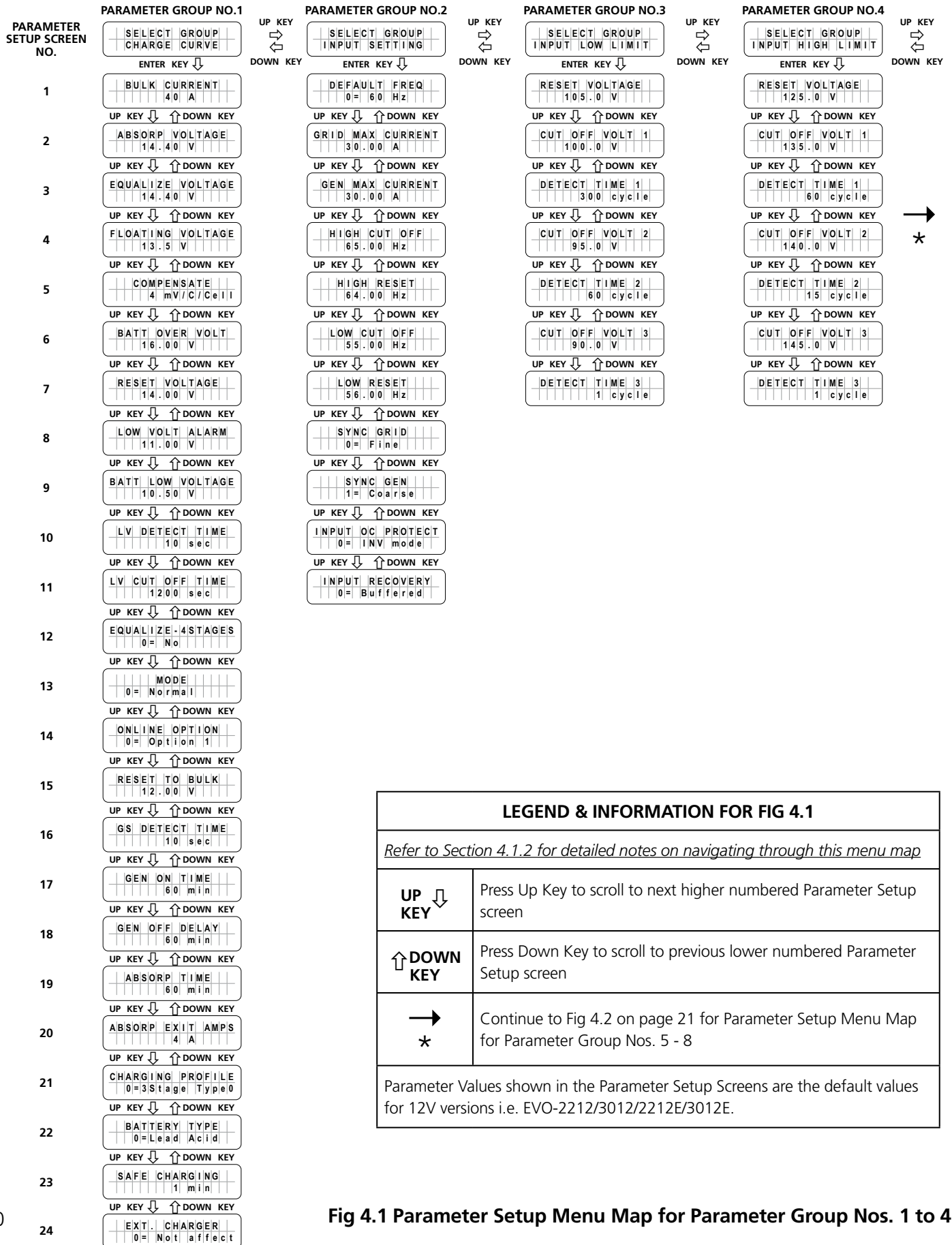

**Fig 4.1 Parameter Setup Menu Map for Parameter Group Nos. 1 to 4**

# SECTION 4 | Parameter Setup

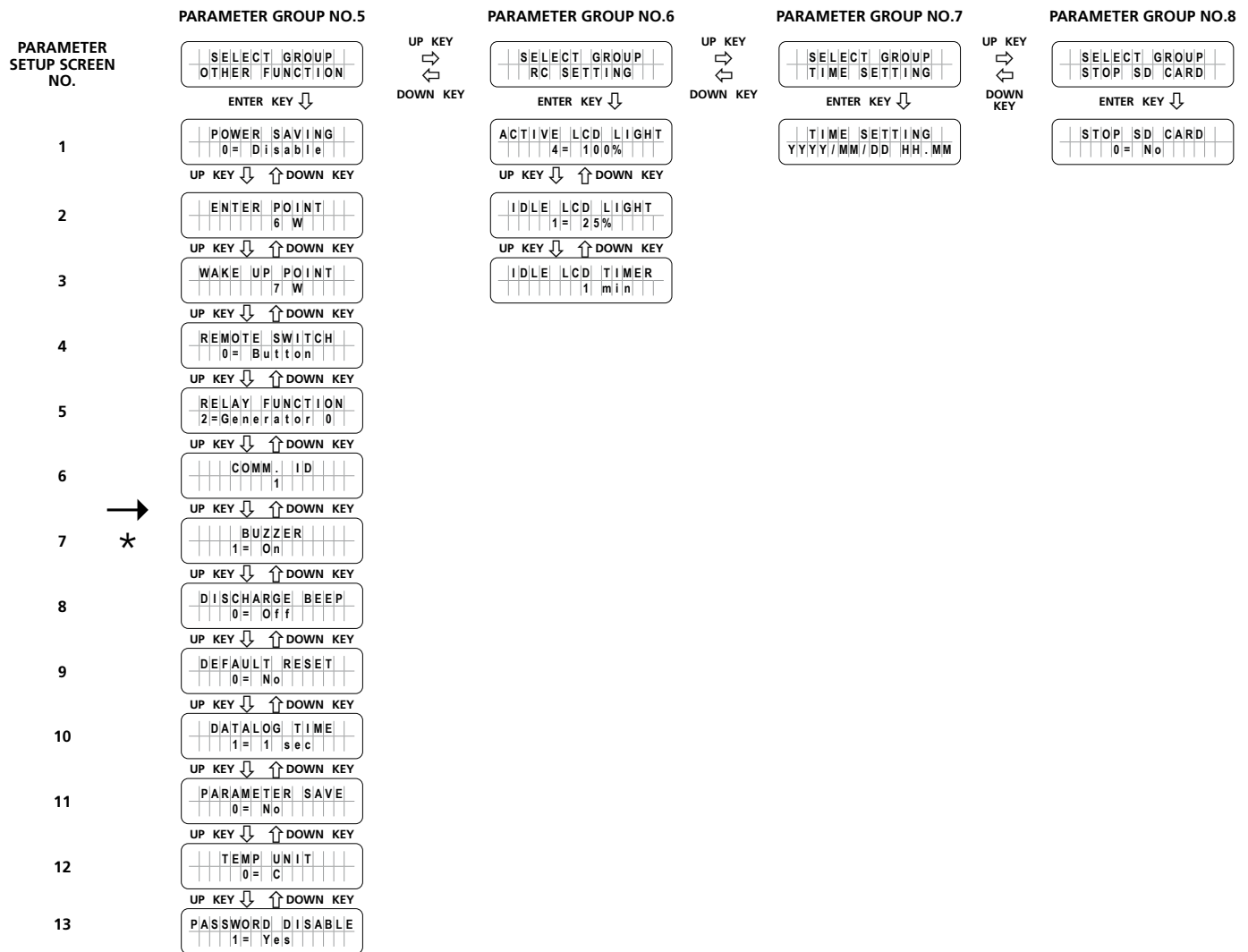

LEGEND & INFORMATION FOR FIG 4.2	
<i>Refer to Section 4.1.2 for detailed notes on navigating through this menu map</i>	
<b>UP KEY</b> ↓	Press Up Key to scroll to next higher numbered Parameter Setup screen
↑ <b>DOWN KEY</b>	Press Down Key to scroll to previous lower numbered Parameter Setup screen
→ *	Continued from Fig 4.1 on page 20 for Parameter Setup Menu Map for Parameter Group Nos. 1 - 4
Parameter Values shown in the Parameter Setup Screens are the default values for 12V versions i.e. EVO-2212/3012/2212E/3012E.	

Fig 4.2 Parameter Setup Menu Map for Parameter Group Nos. 5 to 8

## SECTION 4 | Parameter Setup

### 4.1.2 Navigating Through Parameter Setup Menu Maps at Figs 4.1 & 4.2

- a) Values or parameters shown are the default values for the 12V versions i.e. EVO-2212/3012.  
 b) For details of programmable ranges and default values of each of the parameters, please refer to Tables and names of PARAMETER GROUP NOS. and Sections given below:

Parameter Group No.	Name of Parameter Group	Table No.	Section No.
1	CHARGE CURVE	4.1	4.4
2	INPUT SETTING	4.4	4.5
3	INPUT LOW LIMIT	4.5	4.6
4	INPUT HIGH LIMIT	4.6	4.7
5	OTHER FUNCTION	4.7	4.8
6	RC SETTING	-	4.9
7	TIME SETTING	-	4.10
8	STOP SD CARD	-	4.11

- c) Entering & navigating within Parameter Setup Menu Map (*Figs 4.1 & 4.2*) is explained below:

#### (i) Entering Parameter Setup Menu:

- Press Enter Key from any of the Operating Mode Display Screens (*Figs 3.2 to 3.6*) to go to PARAMETER GROUP NO.1 (*CHARGE CURVE*)

- Screen for PARAMETER GROUP NO.1 named "CHARGE CURVE" will be displayed:

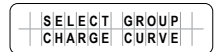

#### NOTE:

The 7 "PARAMETER GROUPS" in Figs 4.1 & 4.2 have the following 2 lines of display:

Line 1: Displays "SELECT PARAMETER"

Line 2: Displays the name of the PARAMETER GROUP (*Names of the 7 PARAMETER GROUPS are shown in Column 2 of Table under Section 4.1.2(b) above*)

#### (ii) Navigating through "PARAMETER GROUP NOS." 1 to 7:

- Press Up Key to scroll right to the next higher numbered "PARAMETER GROUP"
- Press Down Key to scroll left to the previous lower numbered "PARAMETER GROUP"
- Press Enter Key to select the desired PARAMETER GROUP NO. – PARAMETER SETUP SCREEN NO.1 of the selected "PARAMETER GROUP NO." will be displayed
- Press Back Key to go back to the previous Menu Level i.e. the Operating Mode Display Screen from where Parameter Setup Menu was accessed (*Figs 3.2 to 3.6*)

#### (iii) Navigating through PARAMETER SETUP SCREENS under the selected "PARAMETER GROUP":

- Press Up Key to scroll down to the next higher numbered PARAMETER SETUP SCREEN
- Press Down Key to scroll up to the previous lower numbered PARAMETER SETUP SCREEN
- Press Enter Key to select the desired PARAMETER SETUP SCREEN for changing parameter setting
- Press Back Key to go back to previous menu level i.e. "PARAMETER GROUP" (*displayed as "SELECT GROUP"*)

## 4.2 PARAMETER SETUP PROCEDURE

### 4.2.1 General Information

Please refer to Fig 4.3 for general information on navigating the Parameter Setup Menu Maps at Fig 4.1 & 4.2.

# SECTION 4 | Parameter Setup

## 4.2.1.1 Example for Setting Parameter "BULK CURRENT"

Referring to Parameter Setup Menu Maps at Figs 4.1/ 4.2, it is seen that parameter "BULK CURRENT" appears under PARAMETER GROUP NO.1 named "CHARGE CURVE" & PARAMETER SETUP SCREENS NO.1 for parameter "BULK CURRENT".

Example in Fig 4.3 below starts with Inverting Mode Screen (*Screen No.1 of 16 screens under "GROUP 2: INVERTING MODE" - Fig 3.2*). After the **Enter** key is pressed, the **Up/Down** keys are used to navigate through different "PARAMETER GROUP NOS." ("*PARAMETER GROUP NOS.*" 1-4 in Fig 4.1 & "*PARAMETER GROUP NOS.*" 5-8 in Fig 4.2). When the "PARAMETER GROUP" containing the desired parameter is displayed on the LCD (*Group 1 in Fig 4.3*), the **Enter** Key is pressed again to select this "PARAMETER GROUP". When the desired "PARAMETER GROUP NO." is selected, Screen 1 of the sub-menu screens under the selected "PARAMETER GROUP NO." appears ("*BULK CURRENT*" in example shown in Fig 4.3). The **Up** and **Down** Keys are used to navigate through the individual parameters within the selected "PARAMETER GROUP NO."

Pressing the **Back** Key will exit to the previous Menu Level.



**INFO**

There is a 30 second timeout for setting parameters; after 30 seconds the Setting Mode will be cancelled and the EVO-RC will revert to the Operating Mode Screen associated with current operation.

It is highly recommended to set the EVO™ Date and Time (*PARAMETER GROUP NO.7*) as this value is used to record data logging files. (*Refer to Section 4.10 for Date and Time set up*).

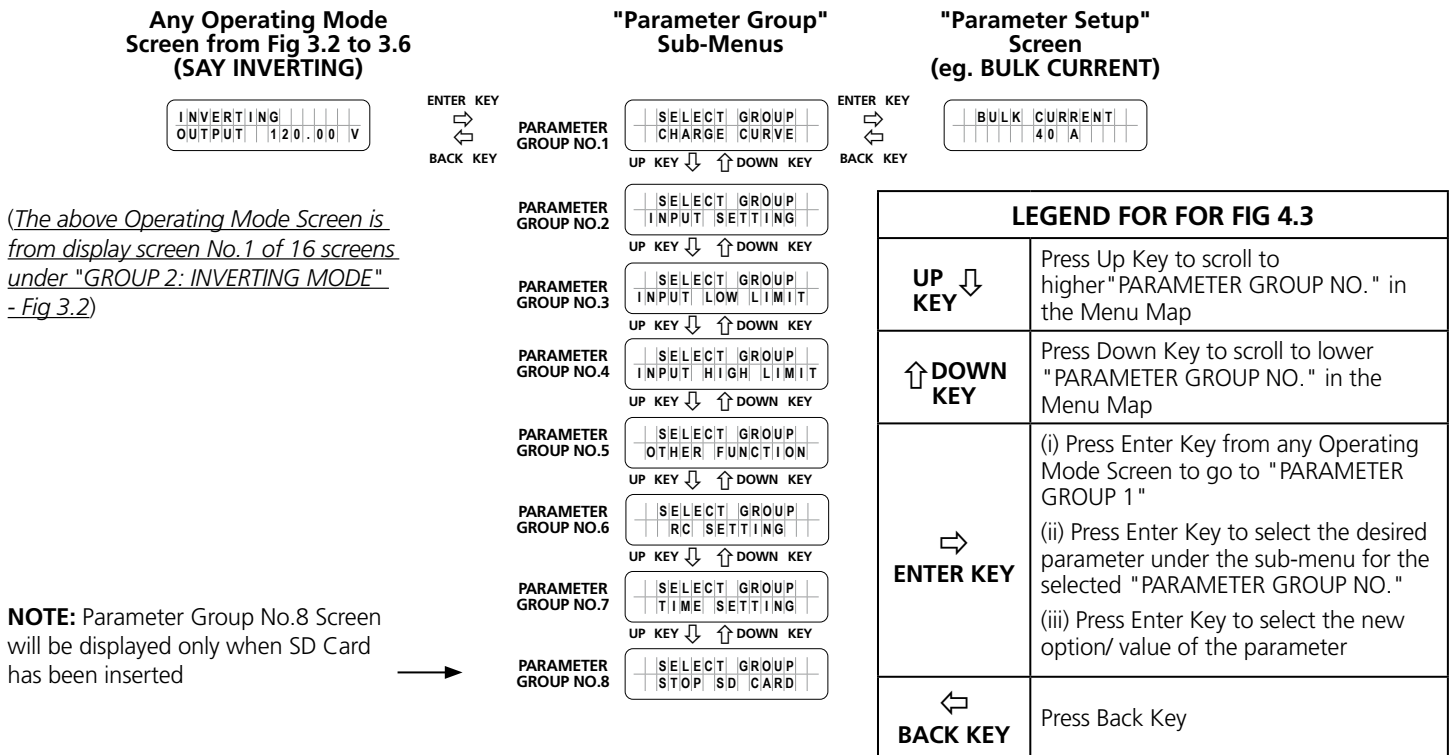

**Fig 4.3 Parameter Setup Procedure – Example for Setting "BULK CURRENT"**

## SECTION 4 | Parameter Setup

### 4.2.2 Changing/ Entering Parameter Values

Each parameter has a programmable range of values specific to the model number of the EVO™. Please refer to Tables 4.1 and 4.4 to 4.8 and Sections 4.10 and 4.11 for details. During parameter programming, the displayed numerical value of the parameter consists of multiple digits that are necessary to display the highest numerical value within the programmable range. For example, the programmable range for the parameter BULK CURRENT for EVO-3012 is 0-130A (*Table 4.1*). The highest numerical value is "130" and consists of 3 digits. Hence, for EVO-3012, the numerical value of BULK CURRENT will be displayed /entered as 3 digits. For example, 1A will be displayed / entered as "001"; 40A will be displayed / entered as "040"; 105A will be displayed / entered as "105" and so on. The overall numerical value of the parameter is changed digit by digit starting from the 1<sup>st</sup> digit on the left. On entering the selected Parameter setup screen (*Figs 4.1 and 4.2*), a cursor will appear under the 1<sup>st</sup> digit and the cursor and the digit will be blinking. Scroll to the desired numerical value for the 1<sup>st</sup> digit using Up and Down Keys. Press the Enter Key momentarily to write the desired numerical value for the 1<sup>st</sup> digit. The cursor will automatically move to the 2<sup>nd</sup> digit on the right. The 2<sup>nd</sup> digit and the cursor and the digit will be blinking. Scroll to the desired numerical value for the 2<sup>nd</sup> digit with the help of Up and Down Keys. Then, press the Enter Key momentarily to write the desired numerical value for the 2<sup>nd</sup> digit. The overall numerical value of the parameter will be selected after scrolling to the desired numerical value for the last digit. Now, press the Enter Key, HOLD for 3 to 4 sec and then release. Process for writing the overall numerical value of the parameter into the memory will be initiated – the screen will display "WRITE SUCCESS!" on completion.

Please read Section 4.3.1 for example of programming a typical parameter – BULK CURRENT



1. When the numerical value for any individual digit is changed that makes the overall numerical value of the parameter outside the programmable range, an Exclamation Sign "!" will appear on the left of the display screen warning you to correct the overall numerical value of the parameter to within the programmable range before writing the new overall numerical value of the parameter to memory. See Tables 4.1 and 4.4 to 4.8 and Sections 4.10 and 4.11 for programming ranges.
2. If, after scrolling to the desired numerical value for the last digit, the overall numerical value of the parameter is out of the programmable range, the Exclamation Sign "!" will continue to appear on the left of the display screen. If an attempt is made to write this "out of range overall numerical value" into the memory (by pressing and holding the Enter Key when the cursor is at the last digit), message "OUT OF RANGE!" will be displayed and the screen will go back to display the originally stored value of the parameter. Parameter set up procedure will have to be re-started.
3. If there is some problem in writing to the memory, message "WRITE FAILURE!" will be displayed. Parameter set up procedure will have to be re-started.

### 4.3 PASSWORD PROTECTION FOR PARAMETER CHANGE

All parameters except Time and Date can be protected with a Password. Programmable Parameter "PASSWORD DISABLE" (See Section 4.8.2.13) is used to disable/ enable password protection. Default setting is enabled (0=No).



## SECTION 4 | Parameter Setup

When the required parameter screen is reached and is displayed and Enter Key is pressed to modify the parameter value, the system will request a 4-digit Password. **The Password is 8052**. Once you **Enter** the Password correctly, you don't need to enter the Password again until any key is not pressed for over 60 seconds. An example of Parameter setting is shown at Section 4.3.1 below:



Password protection is considered desirable to prevent accidental/ un-intentional changes of parameter values.

### 4.3.1 Example of Password Activation and Changing Bulk Current Setting for EVO-2212/3012/4024 from Default Value of 40A to new value of 50A

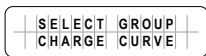

Starting from any of the Operating Mode Screens (*shown at Fig 3.2 to 3.6*), press Enter key. Screen "SELECT GROUP, CHARGE CURVE" as shown on the left will be displayed (*PARAMETER GROUP NO.1 of Menu Map, Fig 4.1*)

Press Enter key to access up to 23 PARAMETER SETUP SCREENS under PARAMETER GROUP NO.1 "CHARGE CURVE", (*Parameters are detailed at Table 4.1 and Fig 4.1*)

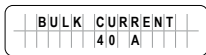

Screen "BULK CURRENT, 40A" as shown on the left will be displayed (PARAMETER SETUP SCREEN NO.1 of PARAMETER GROUP NO.1 "*CHARGE CURVE*", *Fig 4.1*). Default current setting of 40A or previously set value will be displayed.

Press Enter Key to change the value of parameter BULK CURRENT.

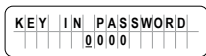

Password - 8052

Password consisting of 4 digits will be requested as shown in the display screen on the left. 4 digits will be displayed (*with initial value 0000*) *with the cursor blinking on the first digit (0) on the left (shows digit "0" and cursor " " alternately)*. Use Up /Down Keys to scroll to number 8 for the first digit "8" of the password. **Momentarily** press Enter Key (**Short press**). Digit 8 will be entered as the first digit of the Password and the blinking cursor will automatically move to the 2<sup>nd</sup> digit (0) to the right. As the next digit in the Password "8052" is "0", **momentarily** press Enter Key (**Short press**) to enter "0" in the second digit. The blinking cursor will automatically move to the 3<sup>rd</sup> digit (0). Use Up /Down Keys to scroll to number 5 for the 3<sup>rd</sup> digit "5" of the password "8052" and **momentarily** press Enter Key (**Short press**). The blinking cursor will automatically move to the 4<sup>th</sup> digit (0). Use Up /Down Keys to scroll to number 2 for the 4<sup>th</sup> digit "2" of the password "8052". Now keep the Enter Key **pressed continuously for longer time (3 to 4 sec)** to write the full password of 4 digits i.e. "8052".

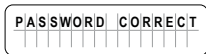

Screen as shown on the left flashes twice when Password is correct. (*8052*)



Screen as shown on the left flashes twice when Password is not correct.

## SECTION 4 | Parameter Setup

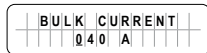

The 1<sup>st</sup> screen of parameter “BULK CURRENT” setting appears as shown on the left. For EVO-2212/3012/4024, the upper limit of the programming range of parameter “BULK CURRENT” is > 100A (see [Table 4.1](#)) and hence, 3 digits will be required to enter value of 100 A and above. Therefore, the default value of 40A will be displayed as “0 40” with alternate blinking of the 1<sup>st</sup> digit between digit “0” and cursor “\_” [NOTE: For EVO-2224, the upper limit of the programming range of parameter “BULK CURRENT” is 70A (see [Table 4.1](#)) and hence, 2 digits will be required. Therefore, the default value of 40A for EVO-2224 will be displayed as 40 with alternate blinking of the 1<sup>st</sup> digit between digit “4” and cursor “\_”]

To change the setting to new value of say 50A, the 3 digits will have to be changed from “040” to “050” value

- As the 1<sup>st</sup> digit of the new setting “050” is “0”, there is no need to change this value. Press the Enter Key **MOMENTARILY** to select “0” for the 1<sup>st</sup> digit. The blinking cursor will automatically move to the 2<sup>nd</sup> digit “4” with alternate blinking of digit “4” and cursor “\_”
- Press the Up Key to scroll the 2<sup>nd</sup> digit to “5”. Press the Enter Key **MOMENTARILY** to select “5” for the 2<sup>nd</sup> digit. The blinking cursor will automatically move to the 3<sup>rd</sup> digit “0” with alternate blinking of digit “0” and cursor “\_”
- As the 3<sup>rd</sup> digit of the new setting “050” is already “0”, there is no need to change this value. Now the overall numerical value will be “050” with alternate blinking of digit “0” and cursor “\_”
- Press the Enter Key, **HOLD for 3 to 4 sec** and then release to initiate writing of the new value of 50A into the memory ([See NOTE below](#))

**NOTE:** When the last digit is changed to the desired digit (“0” in this case) by using the Up / Down Keys, the Enter Key has to be pressed continuously for 3 to 4 sec till message “WRITE SUCCESS” is seen. If the Enter Key is pressed momentarily or for shorter duration (before “WRITE SUCCESS” message is seen), the value will NOT be written into the memory and the cursor will move back to the 1st digit

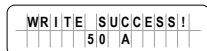

Screen as shown on the left flashes twice when writing is successful.

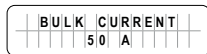

Screen as shown on the left shows end of setting.

Press Back Key to go back to the previous menu level i.e. PARAMETER GROUP NO.1 ([Displayed as “SELECT GROUP CHARGE CURVE”](#)) or Up/Down Key to any of the 23 PARAMETER SETUP SCREENS under the Sub-menu for PARAMETER GROUP NO.1 ([Displayed as “SELECT GROUP CHARGE CURVE”](#)).

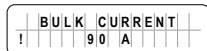

An exclamation sign ‘!’ as shown in screen on the left is displayed when the parameter is out of the specified programming range. For example, if 90A displayed was entered for EVO-2224 ([EVO-2224 range is 0-70A](#)), it will be out of range and an exclamation sign ‘!’ will be displayed.

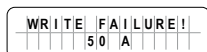

Screen as shown on the left flashes twice when there is a write failure.

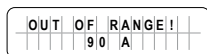

Screen as shown on the left flashes twice when the set value is out of range. ([90A is out of range for EVO-2224 because EVO-2224 range is 0-70A](#)).

All programmable parameters ([See Parameter Setup Menu Maps at Figs 4.1 and 4.2](#)) and their Default Values are described in Sections 4.4 to 4.10.

## SECTION 4 | Parameter Setup

### 4.4 PROGRAMMING INFORMATION FOR PARAMETER GROUP NO.1 – CHARGE CURVE

#### 4.4.1 Programming Ranges & Default Values of Parameters Under Parameter Group No.1 - Charge Curve

Table 4.1 below gives details of programming ranges and default values of parameters under Parameter Group No.1 - "CHARGE CURVE". Refer to the Menu Map in Fig 4.1 ([Section 4.1](#)) for navigating through various parameters under this Parameter Group No.1.

TABLE 4.1 PROGRAMMING INFORMATION FOR PARAMETER GROUP NO.1 – CHARGE CURVE									
Parameter Setup Screen No. for Parameter Group No.1 <i>(Fig 4.1)</i>	Parameter	Programming Range/Options				Default			
		EVO-2212 / EVO-2212E	EVO-3012 / EVO-3012E	EVO-2224 / EVO-2224E	EVO-4024 / EVO-4024E	EVO-2212 / EVO-2212E	EVO-3012 / EVO-3012E	EVO-2224 / EVO-2224E	EVO-4024 / EVO-4024E
1	<b>"BULK CURRENT"</b> <i>(See NOTE 1)</i> <i>(Bulk Charge Current "I<sub>o</sub>")</i>	0-100A	0-130A	0-70A	0-110A	40A			
2	<b>"ABSORP VOLTAGE"</b> <i>(Absorption Voltage)</i>	12.00V - 16.00V		24.00V - 32.00V		14.40V		28.80V	
3	<b>"EQUALIZE VOLTAGE"</b> <i>(Equalization Voltage)</i>	14.00V - 16.50V		28.00V - 33.00V		14.40V		28.80V	
4	<b>"FLOATING VOLTAGE"</b> <i>(Float Voltage)</i>	12.00V - 15.00V		24.00V - 30.00V		13.50V		27.00V	
5	<b>"COMPENSATE"</b> <i>(Temperature Compensation)</i>	3mV to 5mV /C/Cell				4mV /C/Cell			
6	<b>"BATT OVER VOLT"</b> <i>(Battery Over Voltage Shutdown)</i>	14.00V - 17.50V		28.00V - 35.00V		16.00V		32.00V	
7	<b>"RESET VOLTAGE"</b> <i>(Reset voltage for "BATT LOW VOLTAGE" condition)</i>	12.00V - 17.50V		24.00V - 35.00V		14.00V		28.00V	
8	<b>"LOW VOLT ALARM"</b> <i>(Battery Low Voltage Alarm)</i>	9.50V to 13.50V		19.00V to 27.00V		11.00V		22.00V	
9	<b>"BATT LOW VOLTAGE"</b> <i>(Battery Low Voltage Shutdown)</i>	>9.00V to 13.00V		>18.00V to 26.00V		10.50V		21.00V	
10	<b>"LV DETECT TIME"</b> <i>(Time to qualify "BATT LOW VOLTAGE" condition)</i>	0 - 600 sec				10 sec			
11	<b>"LV CUT OFF TIME"</b> <i>(Time in "BATT LOW VOLTAGE" condition to trigger complete shutdown)</i>	0 - 7200 sec				1200 sec			
12	<b>"EQUALIZE-4STAGES"</b> <i>(4 Stage Adaptive Equalization On/ Off)</i>	0 = No (3-Stage / 2-Stage) 1 = Yes (4-Stage Equalization)				0 = No (3-Stage / 2-Stage)			

## SECTION 4 | Parameter Setup

13	"MODE"	0 = Normal.....Grid/Gen priority <i>(Also called Off-Line Mode)</i> 1 = On-Line.....Inverter priority <i>(Also called On-Line Mode)</i> 2 = Charger Only...Charging & AC bypass only, no inverting	0 = Normal
14	"ONLINE OPTION" <i>(Available only when parameter "MODE" is set to Option "1=On-Line")</i>	0 = Option 1 1 = Option 2	0 = Option 1
15	"RESET TO BULK"	10.00V to 13.00V   20.00V to 26.00V	12.00V   24.00V
16	"GS DETECT TIME"	0 - 600 sec	10 sec
17	"GEN ON TIME"	0 - 240 min	60 min
18	"GEN OFF DELAY"	0 - 240 min	60 min
19	"ABSORP TIME"	0 - 600 min	60 min
20	"ABSORP EXIT AMPS"	0 - 20A	4A
21	"CHARGING PROFILE"	0 = 3 Stage Adaptive 1 = 3 Stage Type 1 2 = 3 Stage Type 2 3 = 2 Stage Type 1 4 = 2 Stage Type 2 5 = 2 Stage Type 3	0 = 3 Stage Adaptive
22	"BATTERY TYPE"	0 = Lead Acid 1 = Lithium	0 = Lead Acid
23	"SAFE CHARGING"	0 - 300 min	0 min
24	"EXT. CHARGER"	0 = Affect 1 = Not affect	0 = Affect

### NOTE 1:

"BULK CURRENT" value may automatically reduce in higher ambient temperatures of around 50° - 60°C if Power Transformer temperature exceeds 130°C or Heat Sink temperature exceeds 65°C. See ⓘ INFO under Section 4.4.2.1 for details

### 4.4.2 Description of Parameters Under Parameter Group No.1, "CHARGE CURVE"

#### 4.4.2.1 BULK CURRENT *(Table 4.1, Parameter Setup Screen No.1)*

Parameter "BULK CURRENT" sets the maximum charging current during the Bulk Charging Stage. The default value is 40A.

Normally, Lead Acid batteries should not be charged at very high value of BULK CURRENT as this may damage the batteries due to overheating and cell degradation. Normal BULK CURRENT for Lead Acid Batteries is in the range of 10% to 20% of the Ah capacity of the battery bank at C/20 Discharge Rate. *Lithium Ion Batteries can be charged at much higher Bulk Current as compared to Lead Acid type.* Check with the battery manufacturer regarding recommended BULK CURRENT for your battery bank.

# SECTION 4 | Parameter Setup



## 1. Automatic Reduction of "BULK CURRENT" Setting when Operating in Higher Ambient Temperature

In order to protect against over temperature shut down when operating in higher ambient temperatures, the set value of "BULK CURRENT" is automatically reduced as follows based on temperature sensed at the Power Transformer and at the Heat Sink for the Power Mosfets:

- *Power Transformer Temperature > 130°C*: (i) EVO-2212/2212E: Reduce by 4A every 10 sec, (ii) EVO-3012/3012E: Reduce by 20A every 10 sec, (iii) EVO-2224/2224E: Reduce by 1A every 10 sec, (iv) EVO-4024/4024E: Reduce by 5A every 10 sec.
- *Heat Sink Temperature is > 65°C*: (i) EVO-2212/2212E: Reduce by 4A every 10 sec, (ii) EVO-3012/3012E: Reduce by 20A every 10 sec, (iii) EVO-2224/2224E: Reduce by 1A every 10 sec, (iv) EVO-4024/4024E: Reduce by 5A every 10 sec.

## 2. Automatic Adjustment of "BULK CURRENT" Setting when External Solar Charge Controller is also Charging

In case external Solar Charge Controller is also charging the batteries through DC input terminals marked "EXT Charger", the amount of Bulk Charging Current produced by the internal Battery Charging Section is adjusted in real time to satisfy the following condition:

- Internal Bulk Charging Current = Programmed Value of "BULK CURRENT" – External Charging Current

For example, if the "BULK CURRENT" in the EVO-2212/2212E is programmed at say the default value of 40A and the external Solar Charge Controller is generating 15A, the internal Battery Charging Section of EVO-2212/2212E will reduce its current from 40A to 25A so that the net charging current is equal to the programmed "BULK CURRENT" value of 40A

### 4.4.2.1.1 Programming Steps for Parameter "BULK CURRENT"

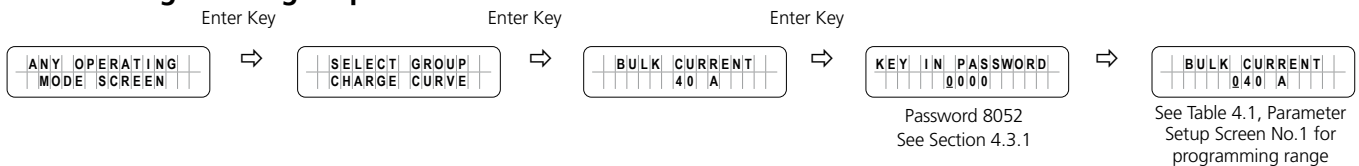

### 4.4.2.2 ABSORP VOLTAGE (Table 4.1, Parameter Setup Screen No.2)

This sets the charging voltage in the Constant Voltage Absorption Stage.

#### 4.4.2.2.1 Programming Steps for Parameter "ABSORP VOLTAGE"

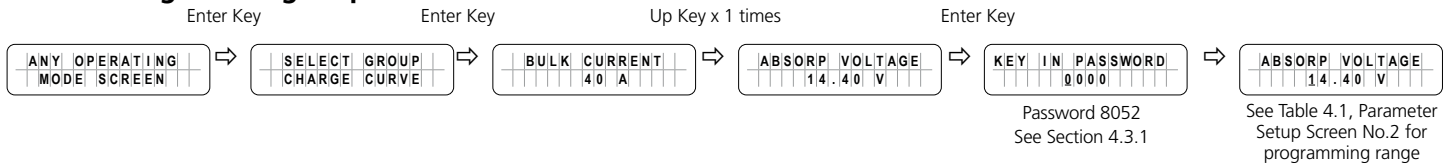

### 4.4.2.3 EQUALIZE VOLTAGE (Table 4.1, Parameter Setup Screen No.3)

This sets the charging voltage in the Constant Voltage Equalization Stage in the 4-stage Adaptive Charging Profile for Equalization.

## SECTION 4 | Parameter Setup

### 4.4.2.3.1 Programming Steps for Parameter "EQUALIZE VOLTAGE"

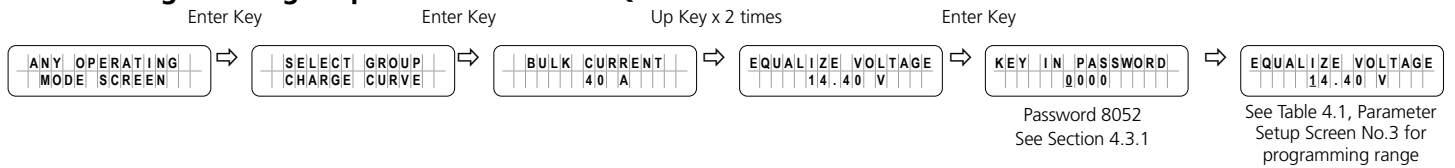

### 4.4.2.4 FLOATING VOLTAGE (Table 4.1, Parameter Setup Screen No.4)

This sets the charging voltage in the Constant Voltage Float Stage.

#### 4.4.2.4.1 Programming Steps for Parameter "FLOATING VOLTAGE"

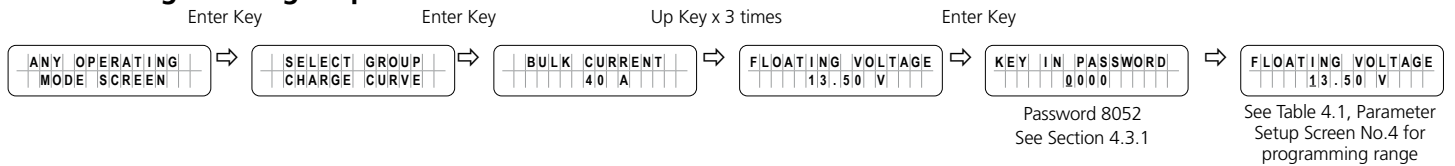

### 4.4.2.5 COMPENSATE (Table 4.1, Parameter Setup Screen No.5)

This parameter sets the temperature compensation for the battery. The operating range of the EVO™ Inverter/Charger is -20°C to 60°C.

This compensation voltage will affect the Absorb Voltage/Equalize Voltage/Floating Voltage/Batt Over Volt/Restart Voltage/Low Volt Alarm/Batt Low Voltage when the Temperature Sensor is installed on the battery (see Fig 2.5 in the *EVO™ Owner's Manual for Evolution™ Series Inverter/Charger*).



#### CAUTIONS!

1. Lithium Ion charging does not require temperature compensation. Hence, do not use EVO-BCTS Temperature Sensor when charging Lithium Ion Batteries.
2. Automatic temperature compensation using EVO-BCTS Temperature Sensor is designed for Lead Acid Batteries based on programming parameter "COMPENSATE". When charging Nickel-Zinc (*Ni-Zn*) batteries, ensure that the value of programming parameter "COMPENSATE" is set based on approximate linear compensation for the particular Ni-Zn battery.



#### ATTENTIONS!

1. Le chargement au lithium-ion ne nécessite pas de compensation de température. Par conséquent, n'utilisez pas le capteur de température EVO-BCTS lors du chargement de batteries au lithium-ion.
2. Compensation automatique de la température à l'aide d'EVO-BCTS Capteur de température est conçu pour les batteries au plomb basée sur la programmation paramètre "COMPENSATE". Lorsque la charge des batteries Nickel-Zinc (Ni - Zn), s'assurer que la valeur du paramètre de programmation "COMPENSATE" est déterminé en fonction du linéaire approximatif pour l'indemnisation de la batterie Ni - Zn particulier.

# SECTION 4 | Parameter Setup

## 4.4.2.5.1 Programming Steps for Parameter "COMPENSATE"

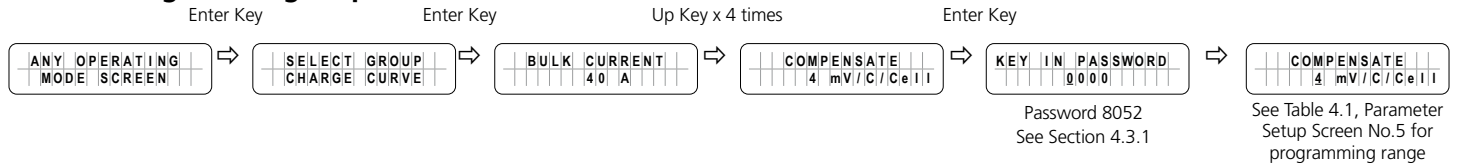

## 4.4.2.6 BATT OVER VOLT (Table 4.1, Parameter Setup Screen No.6)

This parameter sets the upper battery voltage threshold at which inverting / charging operations are switched OFF to protect the unit against damage due to battery overvoltage:

- AC input is not available and EVO™ Inverter/Charger is operating in Inverting Mode:** When the battery voltage rises to the set upper threshold of "BATT OVER VOLT", the Inverter Section will be shut down and fault message "Battery over voltage!" will be displayed on the LCD screen. The Green LED marked "Status" will switch OFF and the Red LED marked "Fault" will remain ON steady. The buzzer on EVO™ Inverter/Charger will beep steady. The fault will be cleared automatically when the battery voltage drops to 0.5V below the set upper threshold of "BATT OVER VOLT"
- AC input is available and EVO™ Inverter/Charger is operating in Charging Mode:** When the battery voltage rises to the set upper threshold of "BATT OVER VOLT", the Transfer Relay will be de-energized, charging and pass through will be stopped and PWM drive to the Inverter Section will be switched OFF. Fault message "Battery over voltage!" will be displayed on the LCD screen. The Green LED marked "Status" will switch OFF and the Red LED marked "Fault" will remain ON steady. The Buzzer on EVO™ Inverter/Charger will beep steady. The fault will be cleared automatically when the battery voltage drops to 0.5V below to the set upper threshold of "BATT OVER VOLT". The unit will start in Inverting Mode, synchronize with the AC input and then, the Transfer Relay will be energized to transfer to AC input at zero crossing. The unit will, thus, resume operation in "Charging Mode".

## 4.4.2.6.1 Programming Steps for Parameter "BATTERY OVER VOLT"

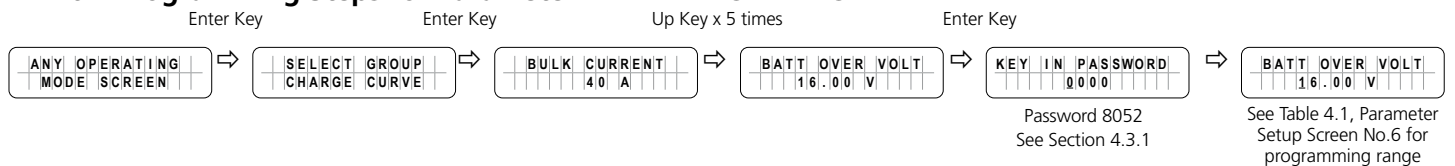

## 4.4.2.7 RESET VOLTAGE (Table 4.1, Parameter Setup Screen No.7)

The inverter will restart when the battery voltage rises above this set value after "Battery low voltage!" shutdown occurs (Table 7.1, Srl No.1). If Relay Function is set for "3 = Generator 1", the relay will turn OFF (See Section 4.8.2.5.2.2).

## 4.4.2.7.1 Programming Steps for Parameter "RESET VOLTAGE"

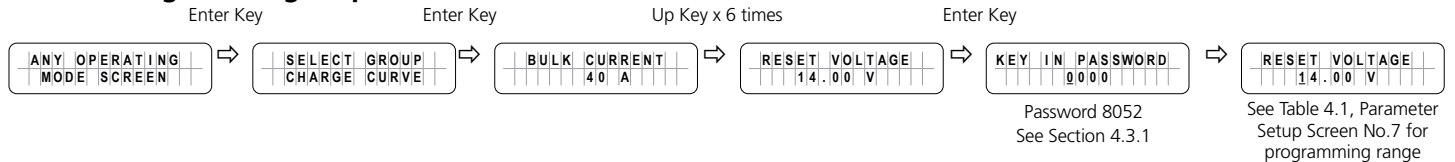

## 4.4.2.8 LOW VOLT ALARM (Table 4.1, Parameter Setup Screen No.8)

When inverting, if battery voltage is under the set value of this parameter, the Red LED marked "Fault" flashes once per second. The buzzer in EVO™ Inverter/Charger will beep once per second. If Relay Function is set for Generator, the relay will turn ON (See Section 4.8.2.5.2). If in On-Line Mode, it will transfer from Inverting Mode to Charging Mode (See Section 4.4.2.13.2).

## SECTION 4 | Parameter Setup

### 4.4.2.8.1 Programming Steps for Parameter "LOW VOLT ALARM"

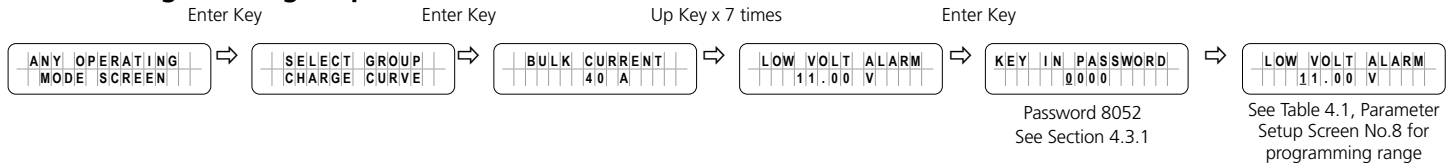

### 4.4.2.9 BATT LOW VOLTAGE *(Table 4.1, Parameter Setup Screen No.9)*

This parameter sets the battery low voltage threshold at which suitable protection is initiated to prevent deep discharge of the battery. The protections are detailed in Sections 4.4.2.9.1 & 4.4.2.9.2 below:

#### 4.4.2.9.1 BATTERY LOW VOLTAGE *[Value of parameter LV CUT OFF TIME (Section 4.4.2.11) set from 1 to 7200 Sec]*

- When the battery voltage drops to the set threshold of "BATT LOW VOLTAGE", the Red LED marked "Fault" will blink once at intervals of 1 sec. The buzzer in EVO™ Inverter/Charger will beep once at intervals of 1 sec. The Inverter Section will continue to operate normally and the Green LED marked "Status" will continue to be ON steady.
- If the battery voltage stays at or below the above threshold for duration equal to the "LV DETECT TIME" *(Section 4.4.2.10)*, only the Inverter Section will be switched OFF and fault message "Battery low voltage!" *(Section 7, Table 7.1, Srl.1)* will be displayed. The Green LED marked "Status" will be switched OFF and the Red LED marked "Fault" will remain ON steady. The buzzer in EVO™ Inverter/Charger will beep steady.
- If the batteries are charged by external Solar Charge Controller connected directly to the batteries or through the External Charger Input *(3, 4 in Fig 2.1 in the EVO™ Owner's Manual)* and the battery voltage recovers to the set "RESET VOLTAGE" *(Section 4.4.2.7)* before the expiry of "LV CUT OFF TIME" *(Section 4.4.2.11)* while in "Battery low voltage!" fault condition, the Inverter Section will restart and the "Battery low voltage!" fault condition will be cleared.
- While in "Battery low voltage!" fault condition *(Section 7, Table 7.1, Srl.1)*, if AC input is made available before the expiry of "LV CUT OFF TIME" *(Section 4.4.2.11)*, the "Battery low voltage!" fault condition will be cleared. The EVO™ Inverter/Charger will restart in Inverter Mode, synchronize with the AC input and then, transfer to the AC input at zero crossing. It will now operate in Charging Mode.
- If the "Battery low voltage!" fault condition is **NOT** reset within the "LV CUT OFF TIME" *(Section 4.4.2.11)*, the EVO™ Inverter/Charger will be shut down completely after the programmed value of LV CUT OFF TIME has elapsed. *The LCD display/ Status LED/ Buzzer will be off in this condition.*

#### 4.4.2.9.2 BATT LOW VOLTAGE *[Value of parameter LV CUT OFF TIME (Section 4.4.2.11) set at 0 Sec]*

When programming value of parameter "LV CUT OFF TIME" *(Section 4.4.2.11)* is set at 0 sec, "Battery low voltage!" fault condition *(Section 7, Srl. 1 of Table 7.1)* will operate as follows:

- a) The unit will NOT shut down completely due to "Battery low voltage!" fault condition *(as in Section 4.4.2.9.1)* but will continue to display fault message "Battery low voltage!" *(Section 7, Srl. 1 of Table 7.1)* after expiry of "LV DETECT TIME" *(Section 4.4.2.10)*.
  - o Green LED marked "Status" *[3 in Fig 1.1(a)]* will be switched off
  - o Red LED marked "Fault /Alarm" *[4 in Fig 1.1(a)]* will be ON steady
  - o Buzzer in the EVO™ Inverter/Charger will beep once at intervals of 1 sec



## SECTION 4 | Parameter Setup

- b1) The unit will automatically switch to “Charging Mode” only under the following conditions:
- If qualified AC input is available that is within the limits of voltage (Sections 4.6 and 4.7) and frequency (Sections 4.5.2.4 and 4.5.2.6)
  - If the battery voltage at the time of qualified AC input availability is higher than “Battery ultra low voltage!” fault threshold of 9V for EVO-2212/2212E/3012/3012E or 18V for EVO-2224/2224E/4024/4024E (Section 7, Srl. 2 of Table 7.1).
- b2) Automatic switching over to “Charging Mode” has 2 options selectable through programming parameter “INPUT RECOVERY” (Section 4.5.2.11) as follows:
- Option 0=Buffered (Default):** Under this option, the unit will initially start in “Inverting Mode”, synchronize with the AC input and then transfer to “Charging Mode”. However, if a user programs the value of “BATTERY LOW VOLTAGE” (Section 4.4.2.9) very close to the “Battery ultra low voltage!” fault threshold of 9V for EVO-2212/3012/2212E/3012E or 18V for EVO-2224/4024/2224E/4024E (Section 7, Srl. 2 of Table 7.1), a larger load / larger starting surge of the load may drag the battery voltage to 9V / 18V or below for 1 ms and trigger “Battery ultra low voltage!” fault (Section 7, Srl. 2 of Table 7.1). Under this condition, the user may change to **Option 1=Direct**
  - Option 1=Direct:** Under this option, the unit will directly start in “Charging Mode”

### 4.4.2.9.3 Programming Steps for Parameter "BATT LOW VOLTAGE"

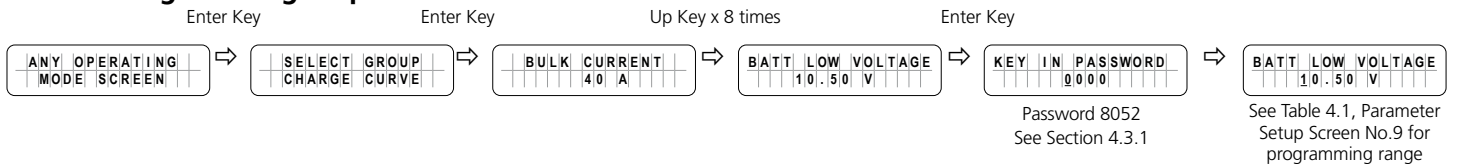

### 4.4.2.10 LV DETECT TIME (Table 4.1, Parameter Setup Screen No.10)

To prevent "Battery low voltage!" fault and shut down of the inverter due to momentary dips in battery voltage as a result of high power, short duration AC loading (*e.g. motor starting, inrush current etc.*), a timer is used to qualify "BATT LOW VOLTAGE" condition only if the battery voltage drops to or below the set “BATT LOW VOLTAGE” threshold for the set “LV DETECT TIME”. The timer starts as soon as the battery voltage drops to the set threshold of “BATT LOW VOLTAGE” described at Section 4.4.2.9.

#### 4.4.2.10.1 Programming Steps for Parameter "LV DETECT TIME"

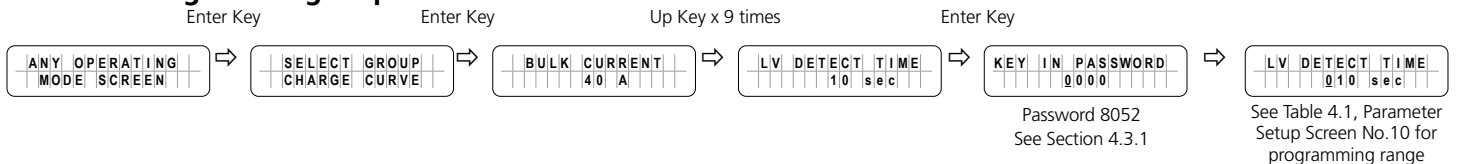

### 4.4.2.11 LV CUT OFF TIME (Table 4.1, Parameter Setup Screen No.11)

#### 4.4.2.11.1 Value of "LV CUT OFF TIME": 1 to 7200 sec

Even when the Inverter Section is shut down due to “Battery low voltage!” fault condition as described at Section 4.4.2.9, there will still be some power drawn from the battery to keep the other circuitry in the EVO™ Inverter/Charger alive so that the inverter can be switched on when the fault gets cleared automatically after the battery has been recharged to the “RESET VOLTAGE” (Section 4.4.2.7) or when AC input voltage is available. However, if the fault is not cleared over a long period of time, the battery may get completely discharged. Hence, a timer is used to record the duration of “Battery low voltage!” condition. The EVO™ Inverter/Charger will be completely shut down (LCD Display / LED / Buzzer will be OFF) when the duration of the “Battery low voltage!” fault condition as described above is equal to the “LV CUT OFF TIME”.

## SECTION 4 | Parameter Setup

### 4.4.2.11.2 Value of "LV CUT OFF TIME": 0 sec

**4.4.2.11.2.1** When the value of parameter "LV CUT OFF TIME" is set at 0 sec, activation and resetting of Battery low voltage! " fault condition (*Section 7, Srl.1 of Table 7.1*) will be as described in Section 4.4.2.9.2.

### 4.4.2.11.3 Programming Steps for Parameter "LV CUT OFF TIME"

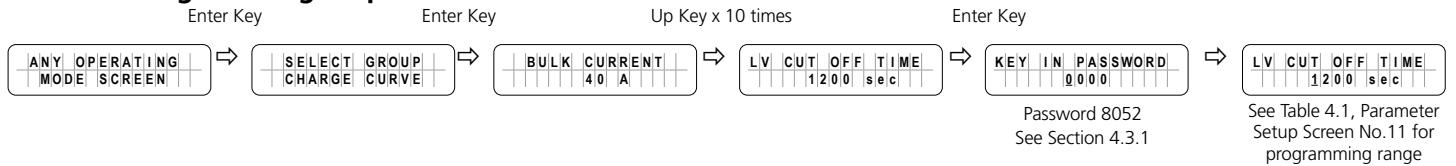

### 4.4.2.12 EQUALIZE – 4 STAGES (*Table 4.1, Parameter Setup Screen No. 12*)



Please refer to Sections 5.8 and 5.9 of EVO™ Owner's Manual for background information on 4-Stage Adaptive Charging Profile for Equalization

When AC input within the programmed window of voltage and frequency is available, the EVO™ will operate as a battery charger and charging will be carried out based on the selected option of parameter "CHARGING PROFILE". Parameter "CHARGING PROFILE" (*Section 4.4.2.21*) allows option to select from 6 Charging Profiles - 3 profiles of 3-Stage and 3 profiles of 2-Stage charging. Default profile option is "0=3 Stage Adaptive"

4-Stage Adaptive Charging Profile for Equalization can be activated AT ANY TIME through programmable parameter "EQUALIZE-4STAGES" set to "1=Yes". The Default Setting is "0=No" i.e. charging will be carried out as per 3 or 2-Stage profile that has been selected by parameter "CHARGING PROFILE" (*Section 4.4.2.21*). After the 4-Stage Adaptive Charging Profile for Equalization is completed, parameter "EQUALIZE-4STAGES" resets automatically to the default setting i.e. Option "0=No" and the charging profile reverts to the last stage of the "CHARGING PROFILE" that was active when 4-Stage Adaptive Charging Profile for Equalization was activated. Details are given at Table 4.2 below:

# SECTION 4 | Parameter Setup

**TABLE 4.2 CHARGING PROFILE FOR 4-STAGE ADAPTIVE CHARGING FOR EQUALIZATION**

Srl No.	Options under Programming Parameter "EQUALIZE-4 STAGES"	Charging Stages	Battery Type
1	<p><b>EQUALIZE – 4 STAGES</b></p> <p>0 = No (Default Setting) 1 = Yes</p>	<p>1. <b>Stage 1 – Bulk Stage</b> (See Section 5.8.2 of the EVO™ Owner's Manual for details):</p> <ul style="list-style-type: none"> <li>Charge at constant current (CC) = the programmed value of parameter "BULK CURRENT" (Default value is 40A. For details of programming range &amp; procedure, refer to Section 4.4.2.1)</li> <li>Transition to Absorption Stage when voltage rises to the set value for programming parameter "ABSORP VOLTAGE" (Default value is 14.4V for EVO-2212/3012 and 28.8V for EVO-2224/4024. For details of programming range &amp; procedure, refer to Section 4.4.2.2)</li> </ul> <p>2. <b>Stage 2 - Absorption Stage</b> (See Section 5.8.2 of the EVO™ Owner's Manual for details):</p> <ul style="list-style-type: none"> <li>Charge at constant voltage (CV) = the programmed value for parameter "ABSORP VOLTAGE". (Default value is 14.4V for EVO-2212/3012 and 28.8V for EVO-2224/4024. For details of programming range &amp; procedure, refer to Section 4.4.2.2)</li> <li><b>Adaptive Time Algorithm:</b> Time in Absorption Stage is computed automatically based on time in Bulk Stage (See Section 5.8.2 of the EVO™ Owner's Manual for details):</li> <li>Transition to Equalization Stage thereafter.</li> </ul> <p>3. <b>Stage 3 - Equalization Stage</b> (See Section 5.8.2 of the EVO™ Owner's Manual for details):</p> <ul style="list-style-type: none"> <li>Charge at constant voltage (CV) = the programmed value of parameter "EQUALIZE VOLTAGE". (Default value is 14.4V for EVO-2212 / EVO-3012 / EVO-2212E / EVO-3012E and 28.8V for EVO-2224 / EVO-4024 / EVO-2224E / EVO-4024E). For details of programming range &amp; procedure, refer to Section 4.4.2.3.</li> <li><b>Adaptive Time Algorithm:</b> Time in Equalization Stage is computed automatically based on time in Bulk Stage. (See Section 5.8.2 of the EVO™ Owner's Manual for details):</li> <li>Transition to <b>Float Stage</b> thereafter.</li> </ul> <p>4. <b>Stage 4 -</b> This stage will be the same as the last Stage of Charging Profile from where Equalization was started. (For details, refer to Table 5.2.1 under Section 5.8.2.4 of the EVO™ Owner's Manual for details):</p>	<p>– Lead Acid: Flooded only</p> <p> <b>CAUTIONS!</b></p> <ol style="list-style-type: none"> <li>Equalize Flooded Lead Acid Batteries. Sealed AGM / Gel Cell types of batteries are NOT equalized</li> <li>Refer to Section 5.8.2 and Fig 5.2 of the EVO™ Owner's Manual.</li> <li>The Adaptive Charging Algorithm measures the Bulk Stage Time (T0) to automatically compute Absorption Stage Time (T1') and Equalization Stage Time (T2). This algorithm is fully effective only when there are no other external DC loads being supplied by the battery that may divert full or part of the BULK CURRENT resulting in undesired increase in Bulk Stage Time "(T0)" and consequently, undesired increase of Absorption Stage Time (T1') and Equalization Stage Time (T2).</li> </ol> <p> <b>ATTENTIONS!</b></p> <ol style="list-style-type: none"> <li>Égaliser les batteries au plomb inondées seulement. Les batteries scellées de type AGM / cellules au gel ne sont pas égalisées.</li> <li>Reportez-vous à la section 5.8.2 et à la figure 5.2 du manuel EVO™ d'utilisation ci-joint pour EVO-2212/3012/2224/4024 et EVO-2212E/3012E/2224E/4024E.</li> <li>L'algorithme de charge adaptative l'essentiel des mesures de phase (T0) pour calculer automatiquement l'étape d'Absorption Temps (T1') et de la péréquation, le temps (T2). Cet algorithme n'est pleinement efficace que lorsqu'il n'y a pas d'autres charges c.c. externe alimenté par la batterie qui peut détourner tout ou partie de l'ACTUEL EN VRAC résultant en une augmentation indésirable en vrac temps Étape "(T0)" et par conséquent, augmentation indésirable de l'étape d'Absorption Temps (T1') et de la péréquation le temps (T2).</li> </ol>

## SECTION 4 | Parameter Setup

### 4.4.2.12.1 Programming Steps for Parameter "EQUALIZE-4STAGES"

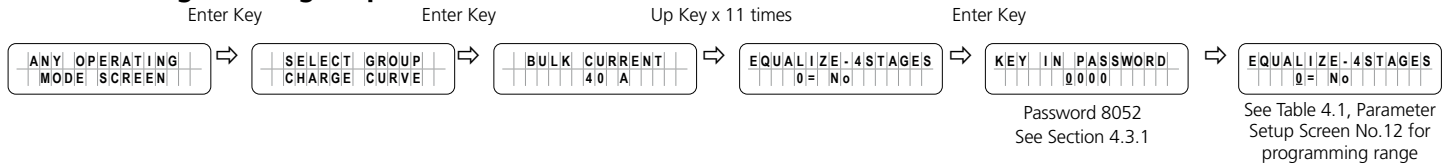

### 4.4.2.13 MODE (Table 4.1, Parameter Setup Screen No. 13)

Under Menu Item "MODE", the following 3 options are available:

- i. **Option: "0=Normal"** (Default). Also called Off-Line Mode. *See details at Section 4.4.2.13.1 below*
- ii. **Option: "1=On-Line"**. *See details at Section 4.4.2.13.2 below*
- iii. **Option: "2=Charger Only"**. *See Section 4.4.2.13.3 below*

#### 4.4.2.13.1 Option: "0=Normal" (Default)

This option is also called "Off-Line UPS Mode" (*UPS stands for **Un**-interruptible **P**ower **S**upply*). In this mode, AC input from the Grid is the PRIMARY source of AC power and the batteries / Inverter Section of EVO™ is the BACK-UP source of DC-AC power. If qualified Grid AC input (*within the programmed voltage and frequency limits*) is available, the EVO™ will operate in "Charging Mode" and qualified Grid AC input will be passed through to the AC output and at the same time, the Internal AC Charger will start charging the batteries. If an external Solar Charge Controller is also connected to the External Charging Terminals (3, 4 in Fig 2.1 of the EVO™ Owner's Manual), the internal AC Charger of EVO™ will limit the charging current as follows:

$$\begin{aligned} &\text{Value of charging current produced by EVO}^{\text{TM}} \\ &\text{Charging Section} \\ &= \text{[Programmed value of charging current set by parameter} \\ &\quad \text{"BULK CURRENT" (Section 4.4.2.1)] minus (Value of current} \\ &\quad \text{fed from the external Solar Charge Controller)} \end{aligned}$$

When Grid AC input fails or, is not within the programmed values of voltage and frequency, the unit will change over to "Inverting Mode" and the AC Output will be fed from the internal Inverter Section of EVO. When the Grid AC input is restored, the EVO™ will revert back to "Charging Mode" to charge the batteries and at the same time, pass through the Grid AC input to the AC output.

*For various display screens under this mode, refer to Fig 3.2*

#### 4.4.2.13.2 Option: "1= On-Line"

This option is also called "On-Line UPS Mode" (*UPS stands for **Un**-interruptible **P**ower **S**upply*). In this mode, the Inverter Section of the EVO™ is the PRIMARY DC-AC source of power. The Grid AC input is the BACK-UP source of AC power. In this mode, even if qualified Grid AC input is available (*within the programmed voltage and frequency limits*), the EVO™ will still operate in "Inverting Mode" and AC output will be provided by the Inverter Section as long as the batteries are in charged condition above the specified programmed value of battery voltage that is set through programmable parameter "LOW VOLT ALARM" – *See Section 4.4.2.8*. When the battery discharges to the programmed voltage threshold of "LOW VOLT ALARM", or lower and remains at this threshold, or below for a sustained programmed time period set by programmable parameter "GS DETECT TIME" (*0-600 sec; Default 10 sec – See Section 4.4.2.16*), the EVO™ will change over to "Charging Mode". On changing over to "Charging Mode", qualified AC input will be passed

## SECTION 4 | Parameter Setup

through to the AC Output and at the same time, the Internal AC Charger will start charging the battery. If an external Solar Charge Controller is also connected to the External Charging Terminals (3, 4 in Fig 2.1 of the EVO™ Owner's Manual), the internal AC Charger will limit the charging current as follows:

$$\begin{array}{l} \text{Value of charging current produced by EVO™} \\ \text{Charging Section} \end{array} = \frac{\text{[Programmed value of charging current set by parameter "BULK CURRENT" (Section 4.4.2.1)] minus (Value of current fed from the external Solar Charge Controller)}}{\text{[Programmed value of charging current set by parameter "BULK CURRENT" (Section 4.4.2.1)] minus (Value of current fed from the external Solar Charge Controller)}}$$

Under the following conditions, "Charging Mode" will be terminated, and the EVO™ will switch back to "Inverting Mode" (Switching from "Charging Mode" back to "Inverting Mode" has 2 options under programming parameter "ONLINE OPTION" - see Section 4.4.2.14 for details):

- i. When the batteries have been re-charged either fully through complete, 3-Stage Charging algorithm (Parameter "ONLINE OPTION" set at "0= Option 1" - See Section 4.4.2.14) or,
- ii. When the batteries have been recharged for a sustained programmed time period set by programmable parameter "GEN OFF DELAY" (0-240 min; Default 60 min" – See Section 4.4.2.17). [Parameter "ONLINE OPTION" set at "1= Option 2" - See Section 4.4.2.14].

### INFO

On-Line Mode is suitable for installations where both Grid and Photovoltaic (PV) Solar Battery Charging System are available. It is also desirable in areas where Grid / Utility Energy Rates are very high and use of supplementary battery based photovoltaic power system is more cost effective.

For various display screens under this mode, refer to Fig 3.3(a) to (d)

#### 4.4.2.13.3 Option: "2=Charger Only".

In Off-grid DC powered homes, for efficiency consideration, all lighting and other loads / appliances are normally powered from batteries that are primarily charged through solar / wind power. Generator backup is used for powering AC to DC battery charger for charging the batteries during extended periods of cloudy / no wind conditions. To meet this requirement, the EVO™ can be programmed to operate as a battery charger ONLY i.e. when AC input power is available within the programmed limits of voltage and frequency, charging will take place and AC input will be passed through to the load(s). The unit will NOT transfer to Inverting Mode if AC input fails or is outside the programmed limits of voltage and frequency. (Refer to Section 3.8 regarding Menu Map for operating Mode Screens during this mode)

- 19 scrollable Operating Mode Screens for Charging Mode will be displayed (See under Column 4 – "GROUP 3: CHARGING MODE" in Fig 3.2). Extract of Screen No.1 is shown below as an example.

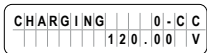

CHARGING 0.CC  
120.00 V

As mentioned above, when the AC input fails, the Inverter Section will NOT be activated, and the AC side loads will lose AC power. EVO™ will operate in Standby Mode as long as AC input power is NOT available.

- Operating Mode Screens for Standby Mode will be displayed (See 7 scrollable Screens under Column 2 – "GROUP 1: STANDBY MODE" in Fig 3.2). Extract of Screen 1 is shown below as an example:

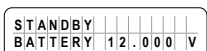

STANDBY BATTERY 12.000 V

## SECTION 4 | Parameter Setup

If attempt is made to exit Standby Mode by momentarily pressing the On/Off Key, the following message will be seen for some time and the screen will revert back to Standby Mode Screen

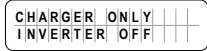

For various display screens under this mode, refer to Figs 3.4(a) & 3.4(b)

### 4.4.2.13.4 Programming Steps for Parameter "MODE"

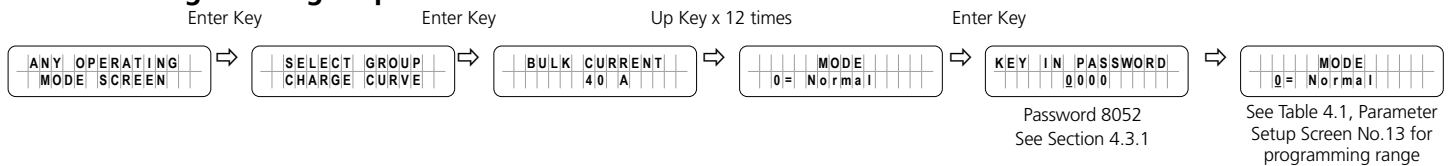

### 4.4.2.14 ONLINE OPTION (Table 4.1, Parameter Setup Screen No. 14)

This setting is effective only when "On-line" Mode is selected (*Parameter "MODE" is set at option "1=On-line". See Section 4.4.2.13*). The default setting is: 0=Option 1. Programming steps are given below:

#### 4.4.2.14.1 Programming Steps for Parameter "ONLINE OPTION"

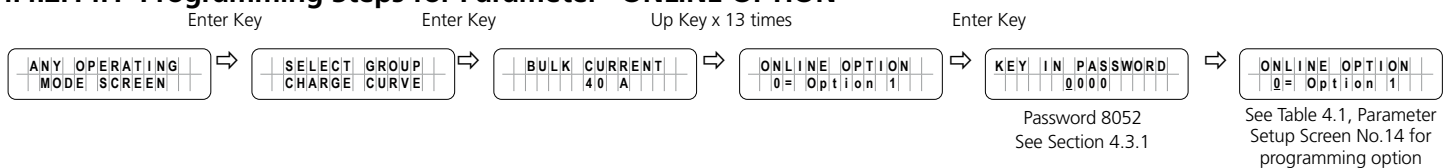

Details of the two options are given below:

0= Option 1 (Default):

- The Transfer Relay will be switched ON (*energized*) if the battery voltage drops to the voltage threshold of "LOW VOLT ALARM" (*Section 4.4.2.8*) or lower for sustained period = "GS DETECT TIME" (*Section 4.4.2.16*). The EVO™ will change over to "Charging Mode" and qualified AC input from the AC input source will be passed through to the AC Output and at the same time, the Internal AC Charger will start charging the battery. If an external Solar Charge Controller is also connected to the External Charging Terminals, the internal AC Charger will limit the charging current to a value = (*Programmed Value of Bulk Current – Value of Current fed from the external Solar Charge Controller*).
- Charging will be carried out till the batteries are charged as follows and then, the Transfer Relay will be de-energized to exit Charging Mode and revert back to Inverting Mode:
  - For Parameter "CHARGING PROFILE" (*Section 4.4.2.21*) set for 3 Stage Charging Profile as per: (i) "Option 0 = 3 Stage Type 0", (ii) Option "1 = 3 Stage Type 1" and (iii) Option "2 = 3 Stage Type 2"
    - The Transfer Relay will be de-energized to exit Charging Mode and revert to Inverting Mode as soon as the battery bank is charged to the voltage threshold set by parameter "FLOATING VOLTAGE" (*Section 4.4.2.4*)
  - For Parameter "CHARGING PROFILE" (*Section 4.4.2.21*) set for 2 Stage Charging Profile as per "Option 3 = 2 Stage Type 1"
    - The Transfer Relay will be de-energized to exit Charging Mode and revert to Inverting Mode when the battery bank is charged to voltage threshold set by parameter "ABSORP VOLTAGE" (*Section 4.4.2.2*) and remains at this level for time period set by parameter "ABSORP TIME" (*Section 4.4.2.19*)

## SECTION 4 | Parameter Setup

- For Parameter **"CHARGING PROFILE"** ([Section 4.4.2.21](#)) set for 2 Stage Charging Profile as per **"Option 4 = 2 Stage Type 2"**
  - The Transfer Relay will be de-energized to exit Charging Mode and revert to Inverting Mode when the battery bank is charged to voltage threshold set by parameter **"ABSORP VOLTAGE"** ([Section 4.4.2.2](#)) and remains at this level for time period of 6 min
- For Parameter **"CHARGING PROFILE"** ([Section 4.4.2.21](#)) set for 2 Stage Charging Profile as per **"Option 3 = 2 Stage Type 3"**
  - The Transfer Relay will be de-energized to exit Charging Mode and revert to Inverting Mode when the battery bank is charged to voltage threshold set by parameter **"ABSORP VOLTAGE"** ([Section 4.4.2.2](#)) and subsequently, the charging current drops to threshold set by parameter **"ABSORP EXIT AMPS"** ([Section 4.4.2.20](#))

1= Option 2:

- The Transfer Relay will be switched ON (*energized*) if the battery voltage drops to **"LOW VOLT ALARM"** ([Section 4.4.2.8](#)), or lower for sustained period = **"GS DETECT TIME"** ([Section 4.4.2.16](#)). The EVO™ will change over to **"Charging Mode"** and qualified AC input from the Grid will be passed through to the AC Output and at the same time, the Internal AC Charger will start charging the battery. If an external Solar Charge Controller is also connected to the External Charging Terminals, the internal AC Charger will limit the charging current to a value = (*Programmed Value of Bulk Current – Value of Current fed from the external Solar Charge Controller*).
- Charging will proceed as per the Charging Profile selected through parameter **"CHARGING PROFILE"** ([Section 4.4.2.21](#))
- The Transfer Relay will be switched OFF (*de-energized*) after the programmed value of **"GEN OFF DELAY"** ([Section 4.4.2.18](#)) counted from the time the battery voltage rises to the programmed value of **"RESET VOLTAGE"** ([Section 4.4.2.7](#)). The unit will exit **"Charging Mode"** and revert to **"Inverting"** Mode.

### 4.4.2.15 RESET TO BULK ([Table 4.1, Parameter Setup Screen No. 15](#))

Refer to the description of 6 types of charging profiles under parameter **"CHARGING PROFILE"** ([Section 4.2.2.21](#)). Parameter **"RESET TO BULK"** sets the value of battery voltage at which the charger will terminate the current charging stage of the selected **"CHARGING PROFILE"** & restart charging from the beginning i.e. from the first **"BULK CURRENT"** stage.

#### 4.4.2.15.1 Programming Steps for Parameter **"RESET TO BULK"**

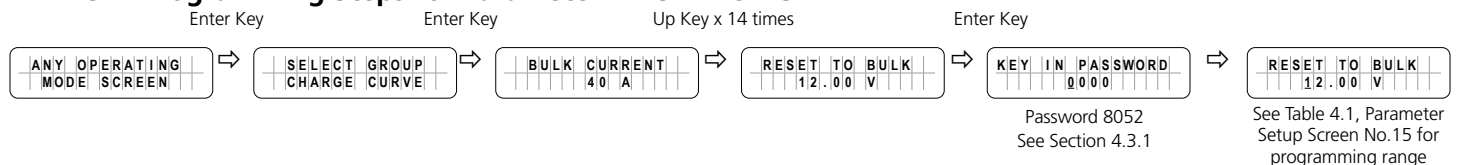

### 4.4.2.16 GS DETECT TIME ([Table 4.1, Parameter Setup Screen No. 16](#))

This parameter is a Programmable Timer (*0-600sec; Default: 10 sec*) that is used for programming On-Line / Off Line UPS Modes ([Section 4.4.2.13](#)) and Automatic Starting and Stopping of Generator ([Section 4.8.2.5 under "Relay Function"](#)). The Timer sets the duration the battery voltage has to remain at threshold of **"LOW VOLT ALARM"** ([Section 4.4.2.8](#)), or lower before the following actions are initiated:

## SECTION 4 | Parameter Setup

- **Automatic Starting and Stopping of Generator:** Switching ON (energizing) the Status Relay to initiate Generator starting
- **On-Line Mode:** Switching ON of the Transfer Relay to transfer from “Inverting” Mode to “Charging” Mode

### 4.4.2.16.1 Programming Steps for Parameter “GS DETECT TIME”

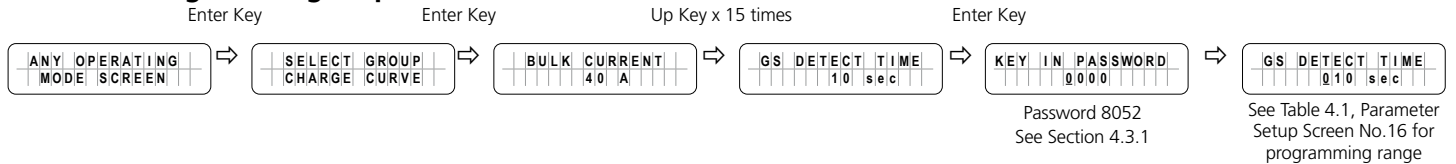

### 4.4.2.17 GEN ON TIME (Table 4.1, Parameter Setup Screen No. 17)

This parameter is a Programmable Timer (*0-240min; Default: 60 min*) that is used for programming Automatic Starting and Stopping of Generator (*Section 4.8.2.5.2.3 under “Relay Function”: Option 4=Generator 2*). The Timer sets the duration the Generator will remain ON from the time the Status Relay has been switched ON (*energized*). The Status Relay will switch ON (*energize*) and start the Generator if the battery voltage remains at threshold of “LOW VOLT ALARM” condition (*Section 4.4.2.8*), or lower for continuous period = “GS DETECT TIME” (*Section 4.4.2.16*).

### 4.4.2.17.1 Programming Steps for Parameter “GEN ON TIME”

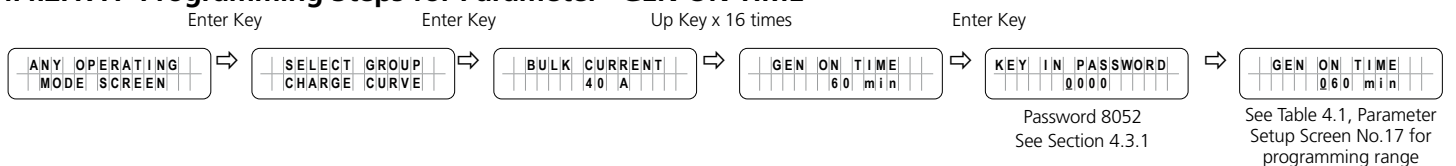

### 4.4.2.18 GEN OFF DELAY (Table 4.1, Parameter Setup Screen No. 18)

This parameter is a Programmable Timer (*0-240min; Default: 60 min*) that is used for the following:

- **Programming Automatic Starting and Stopping of Generator (*Section 4.8.2.5.2.2 under “Relay Function”: 3=Generator 1*):** The Timer sets the time period the batteries are required to remain charged at the desired programmed level of voltage = “RESET VOLTAGE” (*Section 4.4.2.7*), or higher before the Status Relay is switched OFF (*de-energized*) to stop the Generator
- **“ONLINE OPTION” (*Section 4.4.2.14*); “1=Option 2”:** The Timer sets the time period the batteries are required to remain charged at the desired programmed level of voltage = “RESET VOLTAGE” (*Section 4.4.2.7*), or higher before the Transfer Relay is switched OFF (*de-energized*) to exit “Charging” Mode and revert to “Inverting” Mode.

### 4.4.2.18.1 Programming Steps for Parameter “GEN OFF DELAY”

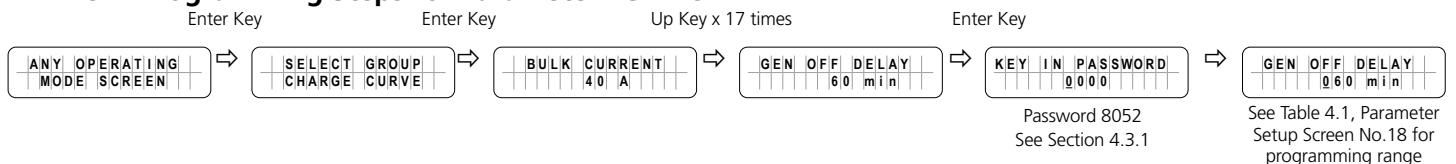

### 4.4.2.19 ABSORP TIME (Table 4.1, Parameter Setup Screen No. 19)

Parameter “ABSORP TIME” is used to set the time the charger will remain in Absorption Stage when the following options for programming parameter “Charging Profile” (*See Section 4.4.2.21*) are selected:

- 1=3 Stage Type 1
- 3=2 Stage Type 1



## SECTION 4 | Parameter Setup



### INFO

When using Charging Profile options (i) "1=3Stage Type 1" or (ii) "3=2Stage Type1, a nearly fully charged battery may be overcharged / boil if the programmed duration of "ABSORP TIME" is excessively long. Care should be taken to determine the time the battery is required to remain in Absorption Stage ("ABSORP TIME") based on the application and then, set programming parameter "ABSORP TIME" accordingly

Programmable range is 0 – 600 min. Default value is 60 min

#### 4.4.2.19.1 Programming Steps for Parameter "ABSORP TIME"

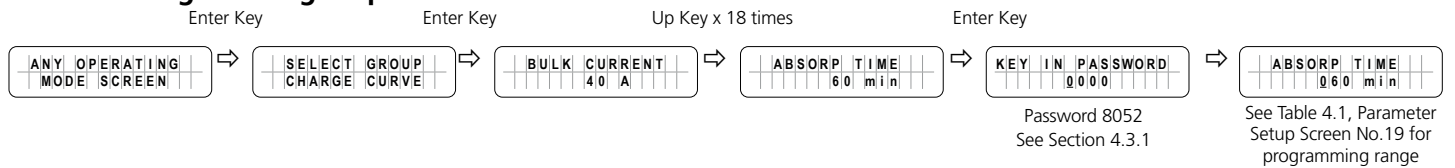

#### 4.4.2.20 ABSORP EXIT AMPS (Table 4.1, Parameter Setup Screen No. 20)

Parameter "ABSORP EXIT AMPS" is used to set the value of the charging current at which the charger will exit Absorption Stage and transition to Float Stage when the following option for programming parameter "Charging Profile" (See Section 4.4.2.21) is selected"

- 2=3 Stage Type 2

Programmable range is 0 – 20A. Default value is 4A

#### 4.4.2.20.1 Programming Steps for Parameter "ABSORP EXIT AMPS"

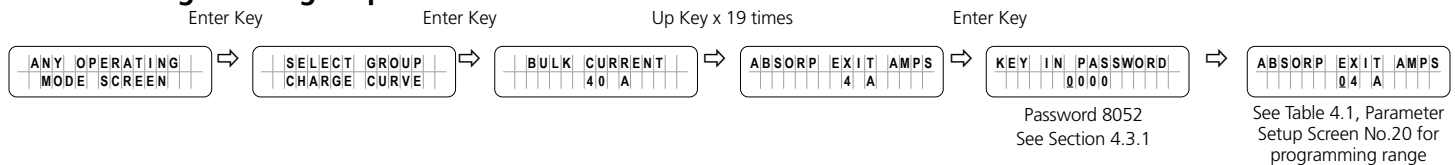

#### 4.4.2.21 CHARGING PROFILE (Table 4.1, Parameter Setup Screen No. 21)

Parameter "CHARGING PROFILE" provides 6 options for Charging Profiles that are designed to cover various charging requirements for Lead Acid, Nickel-Zinc (*Ni-Zn*) and Lithium Ion Batteries.



### INFO

7th Charging Profile i.e. 4-Stage Adaptive Charging Profile for Equalization is also available and can be activated at any time during charging taking place under 1 of the 6 Charging Profile options given at Section 4.4.2.21 above. Procedure to activate 4-Stage Adaptive Charging Profile for Equalization is described under programming parameter "EQUALIZE- 4 STAGES" at Section 4.4.2.12

The 6 options under parameter "CHARGING PROFILE" are as follows:

- 0 = 3 Stage Adaptive (Default)
- 1 = 3 Stage Type 1
- 2 = 3 Stage Type 2
- 3 = 2 Stage Type 1
- 4 = 2 Stage Type 2
- 5 = 2 Stage Type 3

## SECTION 4 | Parameter Setup

**3-Stage Adaptive Charging Profile option "0 = 3 Stage Adaptive** (*Shown as "0=3 Stg Adaptive" in the programming screen*) **is the default charging profile applicable for Lead Acid Batteries**

Details of the 6 programmable charging profiles under programming parameter "CHARGING PROFILE" are given in TABLE 4.3 below.



### CAUTION!

Some Battery Management System (**BMS**) for Lithium Ion Batteries may come with protections for over-charge / over-discharge / over-temperature that will require control over charging and discharging of the battery. For this, any of Pins 1/2/3/4 and 5/6/7/8 of the RJ-45 Jack marked "Battery Temp. Sensor" on the front panel of the EVO™ Inverter/Charger [6, Fig 2.1 in the EVO™ Owner's Manual] may be used to feed potential free contact closing signal from the BMS to "Stop Charging" or "Stop Inverting" [*Refer to Section 4.4.2.22.2 for details*]



### ATTENTIONS!

Certains systèmes de gestion de batterie (BMS) pour batteries au lithium-ion peuvent être livrés avec des protections contre les surcharges / décharges excessives / surchauffes qui nécessiteront un contrôle sur la charge et la décharge de la batterie. Pour cela, l'une des broches 1/2/3/4 et 5/6/7/8 de la prise RJ-45 marquée «Battery Temp. Sensor» sur le panneau avant de l'onduleur / chargeur EVOTM [6, Fig 2.1 in le manuel du propriétaire de l'onduleur / chargeur EVOTM] peut être utilisé pour envoyer le signal de fermeture de contact sans potentiel du BMS vers «Arrêter la charge» ou «Arrêter l'inversion» [*Voir la section 4.4.2.22.2 pour plus de détails*]

# SECTION 4 | Parameter Setup

**TABLE 4.3 CHARGING PROFILE OPTIONS FOR 3 AND 2-STAGE CHARGING**

Srl No.	Options under Programming Parameter "CHARGING PROFILE"	Charging Stages	Battery Type
1	<p>0 = 3 Stage Adaptive (<i>Shown as "0=3 Stg. Adaptive" in the programming screen</i>)</p> <p><b>NOTES:</b></p> <ol style="list-style-type: none"> <li>This is the default setting</li> <li>This is a 3-Stage, Adaptive Profile with "Adaptive Time Algorithm" for the Absorption Stage (<i>For details, refer to Section 5.7.2 of the attached Owner's Manual for EVO-2212/3012/2224/4024 or EVO-2212E/3012E/2224E/4024E.</i>)</li> </ol>	<ol style="list-style-type: none"> <li><b>Stage 1 – Bulk Stage</b> (<i>See Section 5.7.1.1 of the EVO™ Owner's Manual for details:</i>) <ul style="list-style-type: none"> <li>Charge at constant current = the programmed value of parameter "BULK CURRENT" (Default value is 40A. <i>For details of programming range &amp; procedure, refer to Section 4.4.2.1</i>)</li> <li>Transition to Absorption Stage when voltage rises to the set value for programming parameter "ABSORP VOLTAGE" (Default value is 14.4V for EVO-2212/3012 and 28.8V for EVO-2224/4024. <i>For details of programming range &amp; procedure, refer to Section 4.4.2.2</i>)</li> </ul> </li> <li><b>Stage 2 - Absorption Stage</b> (<i>See Section 5.7.2 of the EVO™ Owner's Manual for details:</i>) <ul style="list-style-type: none"> <li>Charge at constant voltage = the programmed value for parameter "ABSORP VOLTAGE". (Default value is 14.4V for EVO-2212/3012/2212E/3012E and 28.8V for EVO-2224/4024/2224E/4024E. <i>For details of programming range &amp; procedure, refer to Section 4.4.2.2</i>)</li> <li><b>Adaptive Time Algorithm:</b> Time in Absorption Stage is computed automatically based on time in Bulk Stage (<i>For details, refer to Section 5.7.2 of the EVO™ Owner's Manual.</i>)</li> <li>Transition to Float Stage thereafter.</li> </ul> </li> <li><b>Stage 3 - Float Stage</b> (<i>See Section 5.7.3 of the EVO™ Owner's Manual for details:</i>) <ul style="list-style-type: none"> <li>Charge at constant voltage = the programmed value for parameter "FLOATING VOLTAGE". (Default value is 13.5V for EVO-2212/3012/2212E/3012E &amp; 27.0V for EVO-2224/4024/2224E/4024E. <i>For details of programming range &amp; procedure, refer to Section 4.4.2.4</i>)</li> <li>Reset to Bulk Stage under the following conditions: <ol style="list-style-type: none"> <li>If the AC input fails or is switched off and is restored subsequently.</li> <li>If battery voltage falls to the programmed value of parameter "RESET TO BULK". (Default value is 12.0V for EVO-2212/3012/2212E/3012E &amp; 24.0V for EVO-2224/4024/2224E/4024E. <i>For details of programming range &amp; procedure, refer to Section 4.4.2.15</i>.)</li> <li>If the charger remains in the Float Stage for 10 days</li> </ol> </li> </ul> </li> </ol>	<ul style="list-style-type: none"> <li>Lead Acid: Flooded and sealed – AGM/ Gel Cell</li> <li><b>ENSURE</b> that there are no other DC load(s) on the batteries. Load(s) on the battery may drain full or part of the charging current and will upset the "Adaptive Time Algorithm" for Absorption Stage time</li> </ul>
2	1=3Stage Type1	<ol style="list-style-type: none"> <li><b>Stage 1 – Bulk Stage</b> (<i>See Section 5.7.1.1 of the EVO™ Owner's Manual for details:</i>) <ul style="list-style-type: none"> <li>Charge at constant current = the programmed value of parameter "BULK CURRENT" (Default value is 40A. <i>For details of programming range &amp; procedure, refer to Section 4.4.2.1</i>)</li> <li>Transition to Absorption Stage when voltage rises to the set value for programming parameter "ABSORP VOLTAGE" (Default value is 14.4V for EVO-2212/3012/2212E/3012E and 28.8V for EVO-2224/4024/2224E/4024E. <i>For details of programming range &amp; procedure, refer to Section 4.4.2.2</i>)</li> </ul> </li> <li><b>Stage 2 - Absorption Stage</b> (<i>See Section 5.7.2 of the EVO™ Owner's Manual for details:</i>) <ul style="list-style-type: none"> <li>Charge at constant voltage (CV) = the programmed value for parameter "ABSORP VOLTAGE". (Default value is 14.4V for EVO-2212/3012/2212E/3012E and 28.8V for EVO-2224/4024/2224E/4024E. <i>For details of programming range &amp; procedure, refer to Section 4.4.2.2</i>)</li> <li>Remain in Absorption Stage for time duration = programmed value of parameter "ABSORP TIME" (Default value is 60 min. <i>For details of programming range &amp; procedure, refer to Section 4.4.2.19</i>)</li> <li>Transition to Float Stage thereafter.</li> </ul> </li> <li><b>Stage 3 - Float Stage</b> (<i>See Section 5.7.3 of the EVO™ Owner's Manual for details:</i>) <ul style="list-style-type: none"> <li>Charge at constant voltage = the programmed value of parameter "FLOATING VOLTAGE". (Default value is 13.5V for EVO-2212/3012/2212E/3012E &amp; 27.0V for EVO-2224/4024/2224E/4024E. <i>For details of programming range &amp; procedure, refer to Section 4.4.2.4</i>)</li> <li>Reset to Bulk Stage under the following conditions: <ol style="list-style-type: none"> <li>If the AC input fails or is switched off and is restored subsequently.</li> <li>If battery voltage falls to the programmed value of parameter "RESET TO BULK". (Default value is 12.0V for EVO-2212/3012/2212E/3012E/ &amp; 24.0V for EVO-2224/4024/2224E/4024E. <i>For details of programming range &amp; procedure, refer to Section 4.4.2.15</i>.)</li> <li>If the charger remains in the Float Stage for 10 days</li> </ol> </li> </ul> </li> </ol>	<ul style="list-style-type: none"> <li>Lead Acid: Flooded and sealed – AGM/ Gel Cell</li> <li>Lithium (<i>See Section 5.11 of EVO™ Owner's Manual for details</i>)</li> </ul>

## SECTION 4 | Parameter Setup

3	2=3Stage Type2	<p>1. <b>Stage 1 – Bulk Stage</b> (See Section 5.7.1.1 of the EVO™ Owner's Manual for details):</p> <ul style="list-style-type: none"> <li>Charge at constant current = the programmed value of parameter "BULK CURRENT" (Default value is 40A. For details of programming range &amp; procedure, refer to Section 4.4.2.1)</li> <li>Transition to Absorption Stage when voltage rises to the set value for programming parameter "ABSORP VOLTAGE" (Default value is 14.4V for EVO-2212/3012/2212E/3012E and 28.8V for EVO-2224/4024/2224E/4024E. For details of programming range &amp; procedure, refer to Section 4.4.2.2)</li> </ul> <p>2. <b>Stage 2 - Absorption Stage</b> (See Section 5.7.2 of the EVO™ Owner's Manual for details):</p> <ul style="list-style-type: none"> <li>Charge at constant voltage = the programmed value for parameter "ABSORP VOLTAGE". (Default value is 14.4V for EVO-2212/3012/2212E/3012E and 28.8V for EVO-2224/4024/2224E/4024E. For details of programming range &amp; procedure, refer to Section 4.4.2.2)</li> <li>Remain in Absorption Stage till the current reduces to value = the programmed value of parameter "ABSORP EXIT AMPS" (Default value is 4A. For details of programming range &amp; procedure, refer to Section 4.4.2.20)</li> <li>Transition to Float Stage thereafter.</li> </ul> <p>3. <b>Stage 3 - Float Stage</b> (See Section 5.7.3 of the EVO™ Owner's Manual for details):</p> <ul style="list-style-type: none"> <li>Charge at constant voltage = the programmed value of parameter "FLOATING VOLTAGE". (Default value is 13.5V for EVO-2212/3012/2212E/3012E &amp; 27.0V for EVO-2224/4024/2224E/4024E. For details of programming range &amp; procedure, refer to Section 4.4.2.4)</li> <li>Reset to Bulk Stage under the following conditions: <ul style="list-style-type: none"> <li>i. If the AC input fails or is switched off and is restored subsequently.</li> <li>ii. If battery voltage falls to the programmed value of parameter "RESET TO BULK". (Default value is 12.0V for EVO-2212/3012/2212E/3012E &amp; 24.0V for EVO-2224/4024/2224E/4024E. For details of programming range &amp; procedure, refer to Section 4.4.2.15).</li> <li>iii. If the charger remains in the Float Stage for 10 days</li> </ul> </li> </ul>	<ul style="list-style-type: none"> <li>– Lead Acid: Flooded and Sealed – AGM/ Gel Cell</li> <li>– Lithium (See Section 5.11 of the EVO™ Owner's Manual for details)</li> </ul>
4	3=2Stage Type1	<p>1. <b>Stage 1 – Bulk Stage</b> (See Section 5.7.1.1 of the EVO™ Owner's Manual for details):</p> <ul style="list-style-type: none"> <li>Charge at constant current = the programmed value of parameter "BULK CURRENT" (Default value is 40A. For details of programming range &amp; procedure, refer to Section 4.4.2.1)</li> <li>Transition to Absorption Stage when voltage rises to the set value for programming parameter "ABSORP VOLTAGE" (Default value is 14.4V for EVO-2212/3012/2212E/3012E and 28.8V for EVO-2224/4024/2224E/4024E. For details of programming range &amp; procedure, refer to Section 4.4.2.2)</li> </ul> <p>2. <b>Stage 2 - Absorption Stage</b> (See Section 5.7.2 of the EVO™ Owner's Manual for details):</p> <ul style="list-style-type: none"> <li>Charge at constant voltage = the programmed value for parameter "ABSORP VOLTAGE". (Default value is 14.4V for EVO-2212/3012/2212E/3012E and 28.8V for EVO-2224/4024/2224E/4024E. For details of programming range &amp; procedure, refer to Section 4.4.2.2)</li> <li>Remain in Absorption Stage till the time in Absorption Stage is = the programmed value of parameter "ABSORP TIME" (Default value is 60 min. For details of programming range &amp; procedure, refer to Section 4.4.2.19)</li> <li>Switch off charging after expiry of programmed value of parameter "ABSORP TIME" (Default value is 60 min. For details of programming range &amp; procedure, refer to Section 4.4.2.19)</li> <li>Reset to Bulk Stage under the following conditions: <ul style="list-style-type: none"> <li>i. If the AC input from the Grid/Generator is disconnected and is reconnected.</li> <li>ii. If battery voltage falls to the programmed value of parameter "RESET TO BULK". (Default value is 12.0V for EVO-2212/3012/2212E/3012E &amp; 24.0V for EVO-2224/4024/2224E/4024E. For details of programming range &amp; procedure, refer to Section 4.4.2.15).</li> </ul> </li> </ul>	<ul style="list-style-type: none"> <li>– Lithium (See Section 5.11 of the EVO™ Owner's Manual for details)</li> <li>– Nickel Zinc (See Section 5.10 of the EVO™ Owner's Manual for details)</li> </ul>

## SECTION 4 | Parameter Setup

5	4=2Stage Type2	<p>1. <b>Stage 1 – Bulk Stage</b> (See Section 5.7.1.1 of the EVO™ Owner's Manual for details):</p> <ul style="list-style-type: none"> <li>Charge at constant current = the programmed value of parameter "BULK CURRENT" (Default value is 40A. For details of programming range &amp; procedure, refer to Section 4.4.2.1)</li> <li>Transition to Absorption Stage when voltage rises to the set value for programming parameter "ABSORP VOLTAGE" (Default value is 14.4V for EVO-2212/3012/2212E/3012E and 28.8V for EVO-2224/4024/2224E/4024E. For details of programming range &amp; procedure, refer to Section 4.4.2.2)</li> </ul> <p>2. <b>Stage 2 - Absorption Stage</b> (See Section 5.7.2 of the EVO™ Owner's Manual for details):</p> <ul style="list-style-type: none"> <li>Charge at constant voltage = the programmed value for parameter "ABSORP VOLTAGE". (Default value is 14.4V for EVO-2212/3012/2212E/3012E and 28.8V for EVO-2224/4024/2224E/4024E. For details of programming range &amp; procedure, refer to Section 4.4.2.2)</li> <li>Remain in Absorption Stage</li> <li>Reset to Bulk Stage under the following conditions: <ul style="list-style-type: none"> <li>i. If the AC input fails or is switched off and is restored subsequently</li> <li>ii. If battery voltage falls to the programmed value of parameter "RESET TO BULK". (Default value is 12.0V for EVO-2212/3012/2212E/3012E &amp; 24.0V for EVO-2224/4024/2224E/4024E. For details of programming range &amp; procedure, refer to Section 4.4.2.15).</li> </ul> </li> </ul>	<p>– Lithium (See Section 5.11 of the EVO™ Owner's Manual for details)</p>
6	5=2Stage Type3	<p>1. <b>Stage 1 – Bulk Stage</b> (See Section 5.7.1.1 of the EVO™ Owner's Manual for details):</p> <ul style="list-style-type: none"> <li>Charge at constant current = the programmed value of parameter "BULK CURRENT" (Default value is 40A. For details of programming range &amp; procedure, refer to Section 4.4.2.1)</li> <li>Transition to Absorption Stage when voltage rises to the set value for programming parameter "ABSORP VOLTAGE" (Default value is 14.4V for EVO-2212/3012/2212E/3012E and 28.8V for EVO-2224/4024/2224E/4024E. For details of programming range &amp; procedure, refer to Section 4.4.2.2)</li> </ul> <p>2. <b>Stage 2 - Absorption Stage</b> (See Section 5.7.2 of the EVO™ Owner's Manual for details):</p> <ul style="list-style-type: none"> <li>Charge at constant voltage = the programmed value for parameter "ABSORP VOLTAGE". (Default value is 14.4V for EVO-2212/3012/2212E/3012E and 28.8V for EVO-2224/4024/2224E/4024E. For details of programming range &amp; procedure, refer to Section 4.4.2.2)</li> <li>Remain in Absorption Stage till the current reduces to value = the programmed value of parameter "ABSORP EXIT AMPS" (Default value is 4A. For details of programming range &amp; procedure, refer to Section 4.4.2.20)</li> <li>Switch off charging after the current reduces to value = the programmed value of parameter "ABSORP EXIT AMPS" (Default value is 4A. For details of programming range &amp; procedure, refer to Section 4.4.2.20)</li> <li>Reset to Bulk Stage under the following conditions: <ul style="list-style-type: none"> <li>i. If the AC input fails or is switched off and is restored subsequently</li> <li>ii. If battery voltage falls to the programmed value of parameter "RESET TO BULK". (Default value is 12.0V for EVO-2212/3012/2212E/3012E &amp; 24.0V for EVO-2224/4024/2224E/4024E. For details of programming range &amp; procedure, refer to Section 4.4.2.15).</li> </ul> </li> </ul>	<p>– Lithium (See Section 5.11 of the EVO™ Owner's Manual for details)</p> <p>– Nickel Zinc (See Section 5.10 of the EVO™ Owner's Manual for details)</p>

### 4.4.2.21.1 Programming Steps for Parameter "CHARGING PROFILE"

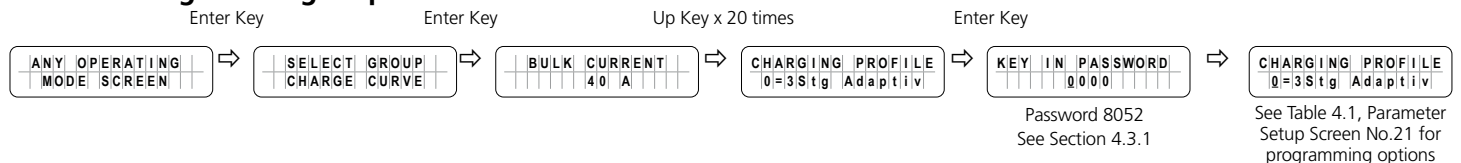

### 4.4.2.22 BATTERY TYPE (Table 4.1, Parameter Setup Screen No. 22)

#### 4.4.2.22.1 General Information

Parameter "BATTERY TYPE" is used to change the functionality of RJ-45 Jack marked "Battery Temp. Sensor" on the front panel of EVO™ [6, Fig 2.1 in the EVO™ Owner's Manual]. The following 2 programming options are available:

## SECTION 4 | Parameter Setup

a) **Option 1 - "0=Lead Acid" (Default setting):** With this default setting, the RJ-45 Jack will be set to accept input from the Battery Temperature Sensor EVO-BCTS [*Fig 2.5(a) in the EVO™ Owner's Manual*] when Lead Acid or Nickel-Zinc (Ni-Zn) batteries are being used. Input from the Battery Temperature Sensor will be used to compensate the charging voltages based on the temperature of the Lead Acid or Nickel-Zinc (*Ni-Zn*) batteries. *Please refer to Section 5.5 of the EVO™ Owner's Manual for more details on temperature compensation for Lead Acid and Nickel-Zinc (Ni-Zn) batteries*

b) **Option 2 - "1=Lithium Ion":** With this setting, the RJ-45 Jack will be programmed to receive and process protection control signals "Stop Charging" or "Stop Inverting" from Lithium Battery Management System (BMS). *Application of this setting is explained at Section 4.4.2.22.2 below*

### 4.4.2.22.2 Stop Charging" and "Stop Inverting" Control by Lithium Ion Battery Management System (BMS)

For protection against over-voltage / over-temperature / over-discharge, Lithium Ion Battery Management Systems (BMS) will normally have capability of providing potential free relay contact closure signal that could be fed to Inverter/Charger to stop charging or stop inverting. For this, the BMS will normally use miniature, Normally Open (*1-Form-A*), Open Drain Opto-Isolated DC Solid-State Relay (SSR). The Solid-State Relay output terminals in the BMS are normally marked "+" (*Drain of Mosfet Switch*) and "-" (*Source of Mosfet Switch*). Example of this type of relay is IXYS Part No. "CPC1002N" (*60V, 700mA rating*).

The following 2 types of signals are normally used by the BMS for on/off control of charging and inverting operation of the Inverter/Charger:

- **"Stop Charging" Signal:** In case of (i) over voltage of individual cell / overall battery pack, or (ii) over temperature of individual cell or overall battery pack, the signal will be "enabled" and SSR contacts will close [*Drain (+) and Source (-) Terminals will be shorted*].
- **"Stop Inverting" Signal:** In case of deep discharge of the battery to the level of Low Battery Cut Off Voltage, the signal will be "enabled" and the SSR contacts will close [*Drain (+) and Source (-) Terminals will be shorted*].

If the above two protection functions of the BMS i.e. "*Stop Charging*" and "*Stop Inverting*" are to be used for on/ off control of charging and inverting operations of EVO™ Inverter/Charger, the following actions will be required to be undertaken:

- a) Programming parameter "**BATTERY TYPE**" must be changed from Option 1 - "0=Lead Acid" (Default setting) to Option 2 - "1=Lithium" [*see Section 4.4.2.21 above*]. With this setting, the function of front panel RJ-45 Jack marked "Battery Temp. Sensor: (*6, Fig 2.1 in the EVO™ Owner's Manual*)" will change from accepting and processing battery temperature signal from the Battery Temperature Sensor EVO-BCTS to accepting and processing potential free relay contact closure signal from the Solid-State Relay from the BMS to stop charging /inverting.
- b) **Wiring Connection:** Output from the SSR Terminals on the Lithium Battery BMS should be wired to the RJ-45 Jack marked "Battery Temp. Sensor" (*6, Fig 2.1 in the EVO™ Owner's Manual*) as follows:
  - Connect terminal marked "+" on the SSR (*Drain of Mosfet switch inside SSR*) to any of pins 1/2/3/4 of RJ-45 Jack (*Pinout shown below*)
  - Connect terminal marked "-" on the SSR (*Source of Mosfet switch inside SSR*) to any of pins 5/6/7/8 of RJ-45 Jack (*Pinout shown below*)

## SECTION 4 | Parameter Setup

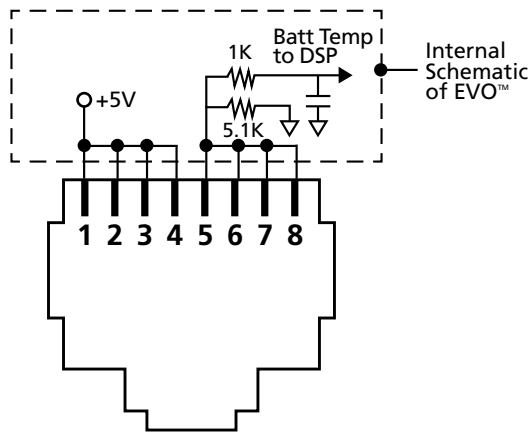

### Pinout of RJ-45 Jack marked "Battery Temp. Sensor" on the Front Panel of EVO™ Inverter/Charger (6, Fig 2.1 in the EVO™ Owner's Manual)

When the Drain-Source terminals of the BMS close, Pins 1/2/3/4 and 5/6/7/8 of RJ-45 Jack will be shorted. The following actions will be activated in EVO:

- **EVO™ in Charging Mode:** Charging will stop (*Internally, the EVO™ will be in Charging Mode, but the charging current will be reduced to 0A*). During this condition, 19 display screens will be available as shown in the Menu Map for Display Screens during "CHGR STOP BY BMS" at Fig 3.5 under Section 3.9.
- Under this condition, the 1st Line of the 19 Screens will show "CHR STOP BY BMS". Example of Screen No. 1 of 19 Screens is shown below:

CHGR	STOP	BY	BMS	
OUTPUT	120	.00	V	

**NOTE:** The 19 "CHGR STOP BY BMS" display screens shown in Fig 3.5 are the same as the 19 display screens shown for Menu Map for screens for "Charging Mode" (Fig 3.2 – Column 3 under heading "GROUP 3: CHARGING MODE") but with the 1st line replaced with "CHGR STOP BY BMS"

- **EVO™ in Inverting Mode:** Inverting will stop (*Internally, the EVO™ will enter Standby Mode*). During this condition, 7 display screens will be available as shown in the Menu Map for display screens during "INV STOP BY BMS" at Fig 3.6 under Section 3.10. Example of Screen No. 1 of 7 Screens is shown below:

INV	STOP	BY	BMS	
BATTERY	12	.000	V	

**NOTE:** The 7 "INV STOP BY BMS" display screens shown in Fig 3.6 are the same as the 7 display screens shown for Menu Map for "Standby Mode" (Fig 3.2 – Column 2 under heading "GROUP 1: STANDBY MODE") but with the 1st line replaced with "INV STOP BY BMS"

## SECTION 4 | Parameter Setup

**NOTE:** Parameter "CHARGING PROFILE" has been set at default option "0=3 Stage Adaptive" for Lead Acid Batteries. This parameter will be required to be programmed to select the desired charging profile for the Lithium Ion Battery from the following options:

- 1=3 Stage Type 1
- 2=3 Stage Type 2
- 3=2 Stage Type 1
- 4=2 Stage Type 2
- 5=2 Stage Type 3

*[For details, please refer to parameter "CHARGING PROFILE" explained under Section 4.4.2.21]*

### 4.4.2.22.3 Programming Steps for Parameter "BATTERY TYPE"

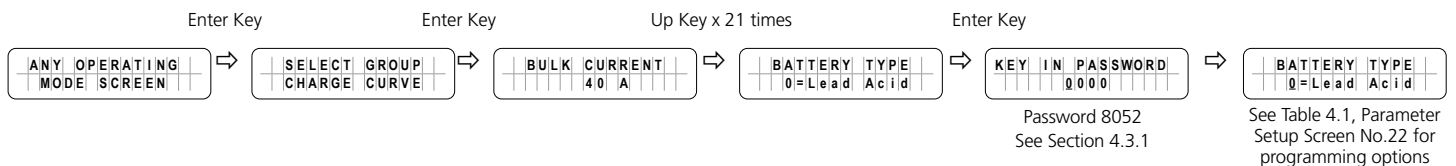

### 4.4.2.23 SAFE CHARGING *(Table 4.1, Parameter Setup Screen No. 23)*

#### 4.4.2.23.1 General Information

Programming parameter "SAFE CHARGING" is a Timer *(0 to 300 min; Default: 0 min)* that may be used for the following operational conditions / requirements:

- The unit is programmed to operate in Normal *[Off-line]* Mode *[Parameter MODE set to "0= Normal" – See Section 4.4.2.13]* i.e. AC input power is the primary source of AC power and EVO's Inverter Section is the backup source.
- The AC load(s) that are fed with backup power from EVO™ have very high inrush current.
- When AC input power is restored during "Battery low voltage!" fault condition *[Section 7, Srl. 1 of Table 7.1]*, EVO™ will exit fault condition and change to "Charging Mode" *[say, "Condition 1"]*. The AC input power may fail again within a short period of time and EVO™ will immediately revert back to "Inverting Mode" *[say, "Condition 2"]*. During "Condition 1", the battery voltage may not have risen appreciably higher than the "BATT LOW VOLTAGE" threshold *[Section 4.4.2.9]*. Hence, during "Condition 2", there would be a likelihood that high inrush current from the AC load(s) would drag the battery voltage down to 9V or lower for EVO-2212/3012/2212E/3012E or 18V or lower for EVO-2224/4024/2224E/4024E. This may trigger "Battery ultra low volt!" fault condition *[Section 7, Srl. 2 of Table 7.1]*. It is, therefore, desirable that when AC input power is restored during "Battery low voltage!" fault condition *(Condition 1)* and fails again *(say Condition 2)*, the AC load(s) should NOT be transferred to the Inverter Section *(under Condition 2)* till the AC input power had been restored *(under Condition 1)* for a minimum safe charging time period set through Timer "SAFE CHARGING" *[Section 4.4.2.23]*

#### 4.4.2.23.2 Initial Settings:

- As an example, assume that the timer associated with parameter "SAFE CHARGING" *[Section 4.4.2.23]* is set to > the Default Setting of 0 min, say "t" min
- Parameter "LV CUT OFF TIME" *[Section 4.4.2.11.2]* is set to 0 sec to ensure that the unit does not shut down completely if AC input is not restored before expiry of time set through programming parameter "LV CUT OFF TIME" *[Section 4.4.2.11]*



## SECTION 4 | Parameter Setup

### 4.4.2.23.3 Operating Sequence

- 1) AC input power is available – EVO™ operates in “Charging Mode”
- 2) AC input power fails: EVO™ transfers from “Charging Mode” to “Inverting Mode”
- 3) The battery continues to get discharged. When battery voltage (i) drops to value equal to / lower than the “BATT LOW VOLTAGE” threshold [Section 4.4.2.9] for period equal to LV DETECT TIME [Section 4.4.2.10] or (ii) momentarily drops for 1 ms to 9V or below for EVO-2212/3012/2212E/3012E or, 18V or below for EVO-2224/4024/2224E/4024E, EVO’s Inverter Section is shut down and displays “Battery low voltage! fault / “Battery ultra low voltage!” fault conditions respectively [See Srls. 1 and 2 of Table 7.1, Section 7].
  - As parameter “LV CUT OFF TIME” [Section 4.4.2.11.2] has been set at 0 sec, the EVO™ does not shut down completely but continues to remain in “Battery low voltage!” / “Battery ultra low voltage!” fault condition
- 4) AC input power is restored and is within the programmed limits of frequency and voltage
- 5) EVO™ exits “Battery low voltage!” / “Battery ultra low voltage!” and starts operating in “Charging Mode” (say, “Operating Condition 1”)
  - As soon as “Charging Mode” is activated, the Timer associated with parameter “SAFE CHARGING” [Section 4.4.2.23] starts countdown:
    - The “SAFE CHARGING” Timer will countdown to “0” min if AC input remains on for more than the programmed value of “t” min
    - The “SAFE CHARGING” Timer will NOT countdown to “0” min if AC input remains on for period less than the programmed value “t” min
- 6) AC input fails again. The EVO™ will now operate as follows based on the condition of the “SAFE CHARGING” Timer that recorded the time AC input was available [“Operating Condition 1” mentioned at Srl. 5 above]:
  - “SAFE CHARGING” Timer value has counted down to 0 min: EVO™ will operate in “Inverting Mode”. As the batteries were re-charged for sizable time period > the programmed time “t” of the “SAFE CHARGING” timer, the battery would have charged appreciably higher than the “BATT LOW VOLTAGE” threshold [Section 4.4.2.9]. Hence, there is less likelihood that high inrush current from the AC loads would drag the battery voltage down to 9V or lower for EVO-2212/3012 or 18V or lower for EVO-2224/4024 to trigger “Battery ultra low volt!” fault condition [See Section 7, Srl. 2 of Table 7.1]
  - “SAFE CHARGING” Timer value has NOT counted down to 0 min: EVO™ will not go to Inverting Mode but to “STANDBY” Mode [See Screen No. 1, of STANDBY MODE screens in Fig 3.2]. As the batteries were re-charged for a short time period < the programmed time “t” of the “SAFE CHARGING” timer (“Operating Condition 1” mentioned at Srl. 5 above), the battery would NOT have charged appreciably higher than the “BATT LOW VOLTAGE” threshold. Hence, there would be a likelihood that high inrush current from the AC loads would drag the battery voltage down to 9V or lower for EVO-2212/3012/2212E/3012E or 18V or lower for EVO-2224/4024/2224E/4024E to trigger “Battery ultra low volt!” fault condition (See Section 7, Srl. 2 of Table 7) that would require manual reset.
    - If the battery is charged through external charging source [e.g. solar charging through Charge Controller connected to the battery directly or, through terminals marked “EXT Charger” on the front panel of the unit (3, 4 in Fig 2.1 in the EVO™ Owner’s Manual)] to voltage threshold set by parameter “RESET VOLTAGE” [Section 4.4.2.7], the EVO™ will change to “INVERTING MODE”

## SECTION 4 | Parameter Setup

### 4.4.2.23.4 Programming Steps for Parameter "SAFE CHARGING"

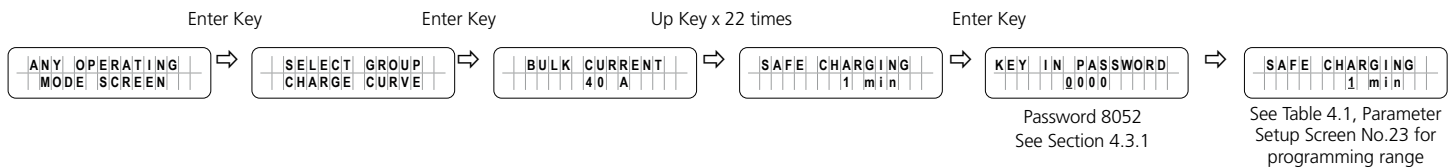

### 4.4.2.24 EXT. CHARGER (Table 4.1, Parameter Setup Screen No. 24)

When AC input is available within the programmed window of AC input voltage and frequency, the batteries will be charged based on the following options selected through programming parameter "EXT. CHARGER":

#### i) Programming Parameter "EXT. CHARGER" set at Default Option "0 = Affect":

This is the default setting. Under this setting, the total charging current will be as follows:

- **Total Charging Current** = Charging current from internal AC charger **PLUS** charging current from the External Solar Charge Controller
  - **Charging current from the Internal AC Charger** = Programmed value of Parameter "BULK CURRENT" (Section 4.4.2.1) **MINUS** value of charging current from the External Solar Charge Controller

#### i) Programming Parameter "EXT CHARGER" set at Option "0 = Not affect":

- **Total Charging Current** = Charging current from internal AC charger **PLUS** charging current from the External Solar Charge Controller
  - **Charging current from internal AC Charger** = Full programmed value of Parameter "BULK CURRENT" (Section 4.4.2.1)

*For further details, please refer to Section 5.4 of the EVO™ Owner's Manual.*

### 4.4.2.24.1 Programming Steps for Parameter "EXT. CHARGER"

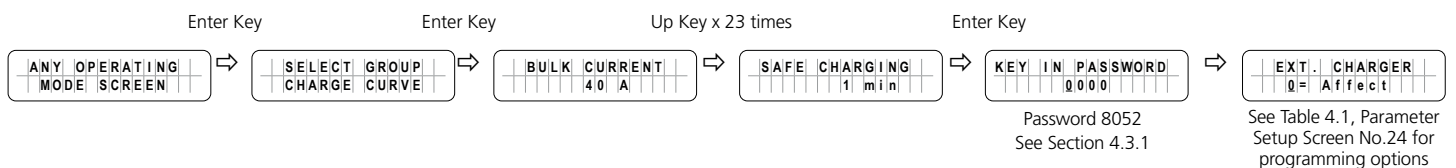

## 4.5 GROUP 2 PARAMETER SET UP: INPUT SETTING

### 4.5.1 Programming Ranges & Default Values of Programming Parameters under Parameter Group 2 – INPUT SETTING

Refer to Parameter Group No.2 at Fig 4.1

Table 4.4 below gives details of programmable ranges & default values of parameters under Parameter Group No.2 - "INPUT SETTING". Refer to Fig 4.1 under Section 4.1 for Menu Map for navigating through various parameters under this Group No.2.

## SECTION 4 | Parameter Setup

**TABLE 4.4 Programming Information for Parameter Group No.2 - INPUT SETTING**

Parameter Setup Screen No. for Parameter Group No.2 (Fig 4.1)	Parameter	Programming Range/Options				Default Value			
		EVO-2212 / EVO-2212E	EVO-3012 / EVO-3012E	EVO-2224 / EVO-2224E	EVO-4024 / EVO-4024E	EVO-2212 / EVO-2212E	EVO-3012 / EVO-3012E	EVO-2224 / EVO-2224E	EVO-4024 / EVO-4024E
1	DEFAULT FREQ	0 = 60Hz; 1 = 50Hz				0 = 60Hz			
2	GRID MAX CURRENT	5 – 40A	5 – 70A	5 – 40A	5 – 70A	30A			
3	GEN MAX CURRENT	5 – 40A	5 – 70A	5 – 40A	5 – 70A	30A			
4	HIGH CUT OFF	50 – 70Hz				65Hz			
5	HIGH RESET	50 – 70Hz				64Hz			
6	LOW CUT OFF	40 – 60Hz				55Hz			
7	LOW RESET	40 – 60Hz				56Hz			
8	SYNC GRID	0=Fine 1=Coarse				0=Fine			
9	SYNC GEN	0=Fine 1=Coarse				1=Coarse			
10	INPUT OC PROTECT	0=INV mode 1=Shutdown				0=INV mode			
11	INPUT RECOVERY	0=Buffered 1=Direct				0=Buffered			

### 4.5.2 Description of Parameters under Parameter Group No.2 – INPUT SETTING



INFO

The values shown under various screens are the Default Values for EVO-2212/2212E

#### 4.5.2.1 DEFAULT FREQ: (Table 4.4, Parameter Setup Screen No.1)

Default frequency sets the Inverter frequency, which is also the standard frequency for AC input.

##### 4.5.2.1.1 Programming Steps for Parameter "DEFAULT FREQUENCY"

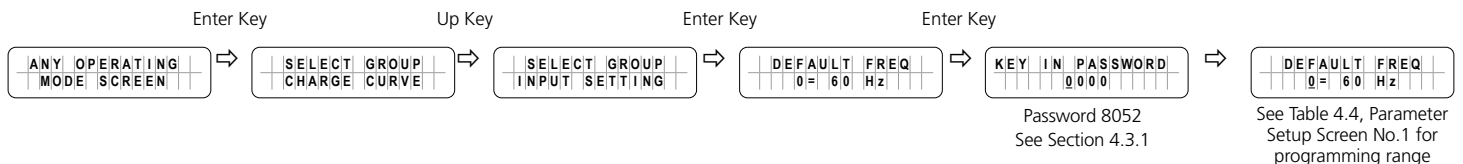

#### 4.5.2.2 GRID MAX CURRENT (Table 4.4, Parameter Setup Screen No.2)

In Charging Mode, the net AC input current from the AC input terminals marked "GRID" is the sum of the AC side charging current and the pass through load current. Based on the rated capacity of the AC input source connected to these terminals, the net AC input current will be required to be limited to prevent overloading of the Input Branch Circuit connected to these terminals.

## SECTION 4 | Parameter Setup

EVO™ Series has a very powerful battery charger that will require a proportionate higher AC input current from the AC input source. The Input Branch Circuit will also be required to provide current to the AC loads. The desired maximum value of input current from the AC input terminals marked "GRID" can be programmed (*Default is 30A*). The EVO™ will automatically reduce charging current to support the AC loads on priority and use whatever is extra for charging. This will prevent overloading of the AC Input Branch Circuit. If the net AC input current is 1A more than the value of parameter "GRID MAX CURRENT" for 1 sec, the AC side charging current is clawed back to ensure that "GRID MAX CURRENT" value is not exceeded. If the value of pass through load current increases to a value of 1A more than the programmed value of "GRID MAX CURRENT" for 5 sec, input over current protection will be activated based on option to either transfer to Inverting Mode or to shut down the EVO™ (*Refer to details of these 2 options under parameter **INPUT OC PROTECT** at Section 4.5.2.10*):

### 4.5.2.2.1 Programming Steps for Parameter "GRID MAX CURRENT"

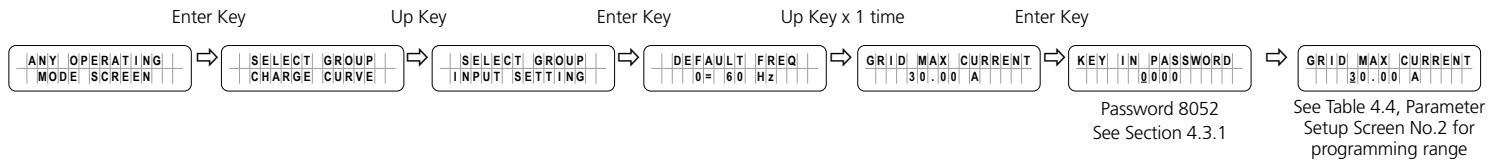

### 4.5.2.3 GEN MAX CURRENT (Table 4.4, Parameter Setup Screen No.3)

In Charging Mode, the net AC input current from the AC input terminals marked "GEN" is the sum of the AC side charging current and the pass through load current. Based on the rated capacity of the AC source connected to AC Input Terminals marked "GEN", the net AC input current will be required to be limited to prevent overloading of the AC input source.

EVO™ Series has a very powerful battery charger that will require a proportionate higher AC input current from the AC input source. The AC source connected to AC input terminals marked "GEN" will also be required to provide current to the AC loads. The desired maximum value of input current from the AC input source connected to AC input terminals marked "GEN" can be programmed (*Default is 30A*). The EVO™ will automatically reduce charging current to support the AC loads on priority and use whatever is extra for charging. This will prevent overloading of the AC input source. If the net AC input current is 1A more than the value of parameter "GEN MAX CURRENT" for 1 sec, the AC side charging current is clawed back to ensure that "GEN MAX CURRENT" value is not exceeded. If the value of pass through load current increases to a value of 1A more than the programmed value of "GEN MAX CURRENT" for 5 sec, input over current protection will be activated based on option to either transfer to Inverting Mode or to shut down the EVO™ (*Refer to details of these 2 options under parameter **INPUT OC PROTECT** at Section 4.5.2.10*):

### 4.5.2.3.1 Programming Steps for Parameter "GEN MAX CURRENT"

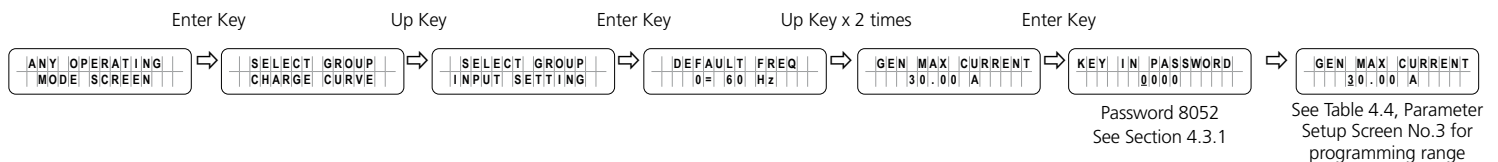

### 4.5.2.4 HIGH CUT OFF (Table 4.4, Parameter Setup Screen No.4)

If the AC input frequency is over the value of "HIGH CUT OFF" when in "Charging Mode", the EVO™ Inverter/Charger will transfer to Inverting Mode.

## SECTION 4 | Parameter Setup

### 4.5.2.4.1 Programming Steps for Parameter "HIGH CUT OFF"

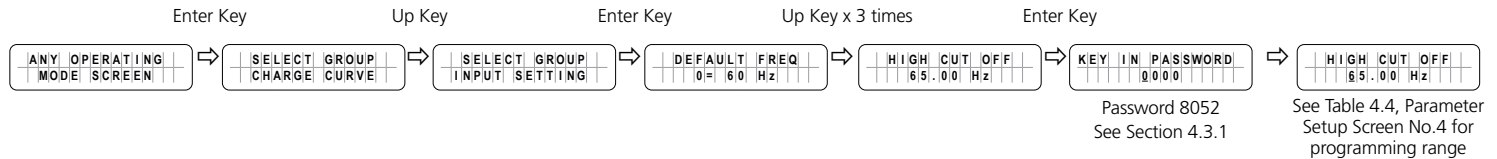

### 4.5.2.5 HIGH RESET (Table 4.4, Parameter Setup Screen No.5)

This is the reset frequency at which the unit will revert to "Charging Mode" after it has switched over to "Inverter Mode" due to input frequency rising above "HIGH CUT OFF".

#### 4.5.2.5.1 Programming Steps for Parameter "HIGH RESET"

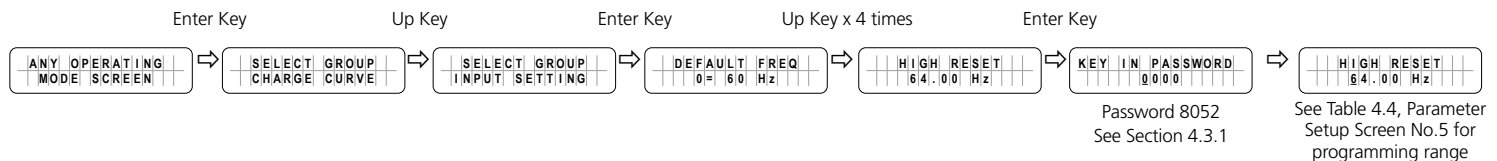

### 4.5.2.6 LOW CUT OFF (Table 4.4, Parameter Setup Screen No.6)

If the AC input frequency is below "LOW CUT OFF" value when in "Charging Mode", the EVO™ Inverter/Charger will transfer to Inverting Mode.

#### 4.5.2.6.1 Programming Steps for Parameter "LOW CUT OFF"

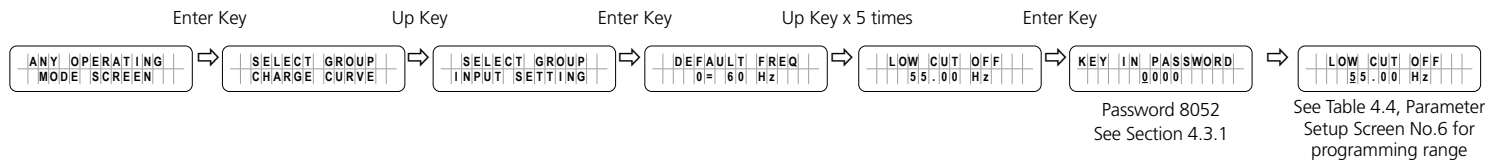

### 4.5.2.7 LOW RESET (Table 4.4, Parameter Setup Screen No.7)

This is the reset frequency at which the unit will revert to "Charging Mode" after it has switched over to "Inverting Mode" due to input frequency falling below "LOW CUT OFF".

#### 4.5.2.7.1 Programming Steps for Parameter "LOW RESET"

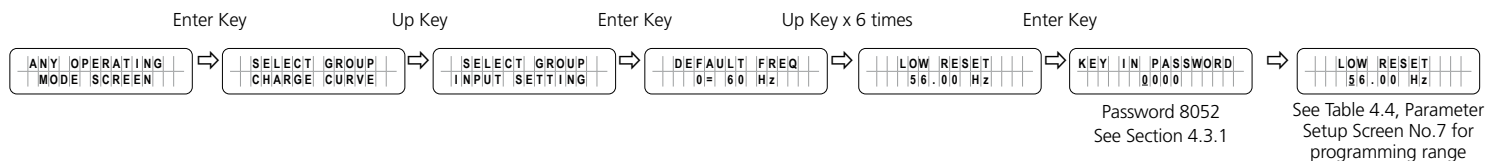

### 4.5.2.8 SYNC GRID (Table 4.4, Parameter Setup Screen No.8)

In EVO™, the frequency and phase of the Inverter Section are always kept synchronized with the AC input source connected to terminals marked "GRID" (4,5,6 in Fig 2.3). This facilitates faster and safer transfer of power between the Inverter Section and the AC input source. *For supplementary details on synchronized transfer of AC power, please refer to Sections 4.5.4 to 4.5.7 of the EVO™ Owner's Manual.*

## SECTION 4 | Parameter Setup

Parameter "SYNC GRID" is used to program the desired *sensitivity* of frequency and phase synchronization of the Inverter Section with the AC input voltage fed at the AC Input Terminals marked "GRID" (4,5,6 in Fig 2.3). 2 programming options are available for this parameter: (i) Option "0= Fine" (Default option) – see Section 4.5.2.8(a) below and (ii) Option "1= Coarse" – see Section 4.5.2.8(b) below.

When EVO™ is operating in Inverting Mode (*there is no AC input*), its output frequency will be equal to the frequency that has been selected by the programming parameter "DEFAULT FREQ" i.e. 60Hz (*Default*) or 50Hz (*See TABLE 4.4 and Section 4.5.2.1*). When AC input is made available at AC Input Terminals marked "GRID" (4,5,6 in Fig 2.3), it is first monitored for 2 sec. If it is within the programmed values of (i) frequency limits (TABLE 4.4), (ii) low voltage limits (TABLE 4.5) and (iii) high voltage limits (TABLE 4.6), synchronization process is initiated to synchronize the frequency and phase of the Inverter Section with the incoming AC input voltage. Details are given below:

### a) Parameter SYNC GRID set at Option "0= Fine" (Default)

This is the "*Default Setting*". This setting is applicable when Grid / Inverter Generator is connected to AC Input Terminals marked "GRID" (4,5,6 in Fig 2.3). Synchronization control logic used in this option is suitable for more stable frequency output of Grid / Inverter Generator. Under this option, the frequency and phase of the Inverter Section are synchronized with the Grid as follows:

- i. First, the frequency of the Inverter Section is tracked in steps of 0.1Hz per cycle and made equal to the frequency of the Grid / Inverter Generator input.
- ii. Then, the phase of the Inverter voltage relative to the Grid voltage is tracked by 1° per cycle. When the phase of the Inverter voltage is within  $\pm 3.5^\circ$  of the input voltage waveform, the Transfer Relay is activated to transfer the AC load from the Grid / Inverter Generator to the Inverter Section at zero crossing of the voltage waveform.

### b) Parameter SYNC GRID set at Option 1= Coarse

This setting is selected if a Generator is connected to AC Input Terminals marked "GRID" (4,5,6 in Fig 2.3). As compared to very stable frequency of Grid / *Inverter Generator*, the frequency of a Generator may vary considerably depending upon the performance of its Speed Governor that compensates for the drop in RPM / frequency when electrical load is switched on / increased or, rise in RPM / frequency when electrical load is decreased /switched off. Hence, if synchronization sensitivity set is at "0= Fine" as in Section 4.5.2.8(a) above, it may take very long for the Inverter Section to synchronize with the Generator or, may not synchronize at all. Under this option, the frequency and phase of the Inverter Section are synchronized with the Generator *differently* as follows:

- i. First, the frequency of the Inverter Section is NOT tracked at 0.1Hz per cycle as in Option "0= Fine" [See Section 4.5.2.8(a) above] but is made equal to the Generator frequency at zero crossing of the Inverter voltage.
- ii. Then, the phase of the Inverter voltage relative to the phase of the Generator voltage is tracked by 1° per cycle. When the phase of the Inverter Section is within  $\pm 10.5^\circ$  of the Generator input voltage waveform, the Transfer Relay is activated to transfer the AC load from the Generator to the Inverter Section at zero crossing of the voltage waveform.

#### 4.5.2.8.1 Programming Steps for Parameter "SYNC GRID"

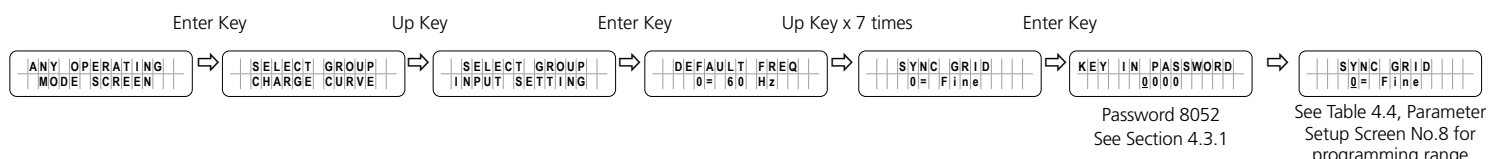

## SECTION 4 | Parameter Setup

### 4.5.2.9 SYNC GEN (Table 4.4, Parameter Setup Screen No.9)

In EVO™, the frequency and phase of the Inverter Section are always kept synchronized with the AC input source connected to terminals marked "GEN" (7,8,9 in Fig 2.3). This facilitates faster and safer transfer of power between the Inverter Section and the AC input source. For supplementary details on synchronized transfer of AC power, please refer to Sections 4.5.4 to 4.5.7 of the EVO™ Owner's Manual.

Parameter "SYNC GEN" is used to program the desired sensitivity of frequency and phase synchronization of the Inverter Section with the AC input voltage fed at the AC Input Terminals marked "GEN" (7,8,9 in Fig 2.3). 2 programming options are available for this parameter: (i) Option "1= Coarse" (Default option) – see Section 4.5.2.9(a) below and (ii) "Option 0= Fine" – see Section 4.5.2.9(b) below

When EVO™ is operating in Inverting Mode (there is no AC input), its output frequency will be equal to the frequency that has been selected by the programming parameter "DEFAULT FREQ" i.e. 60Hz (Default) or 50Hz (See TABLE 4.4 and Section 4.5.2.1). When AC input is made available at AC Input Terminals marked "GEN" (7, 8, 9 in Fig 2.3), it is first monitored for 2 sec. If it is within the programmed values of (i) frequency limits (TABLE 4.4), (ii) low voltage limits (TABLE 4.5) and (iii) high voltage limits (TABLE 4.6), synchronization process is initiated to synchronize the frequency and phase of the Inverter Section with the incoming AC input voltage. Details are given below:

#### a) Parameter SYNC GEN set at Option 1= Coarse (Default)

This is the "Default Setting". This setting is applicable when a Generator is connected to AC Input Terminals marked "GEN" (7,8,9 in Fig 2.3). As compared to very stable frequency of Grid / Inverter Generator, the frequency of a Generator may vary considerably depending upon the performance of its Speed Governor that compensates for the drop in RPM / frequency when electrical load is switched on / increased or, rise in RPM / frequency when electrical load is decreased / switched off. Hence, if synchronization sensitivity is set at "0= Fine" as in Section 4.5.2.9 (b) below, it may take very long for the Inverter Section to synchronize with the Generator or, may not synchronize at all. Under this option, the frequency and phase of the Inverter Section are synchronized with the Generator differently as follows:

- i. First, the frequency of the Inverter Section is NOT tracked at 0.1Hz per cycle as in Option "0= Fine" [See Section 4.5.2.9(b) below] but is made equal to the Generator frequency at zero crossing of the Inverter voltage.
- ii. Then, the phase of the Inverter voltage relative to the Generator voltage is tracked by 1° per cycle. When the phase of the Inverter Section is within  $\pm 10.5^\circ$  of the Generator input voltage waveform, the Transfer Relay is activated to transfer the AC load from the Generator to the Inverter Section at zero crossing of the voltage waveform

#### b) Parameter SYNC GEN set at Option "0= Fine"

This setting is selected if Grid / Inverter Generator is connected to AC Input Terminals marked "GEN" (7,8,9 in Fig 2.3). Synchronization control logic used in this option is suitable for more stable frequency output of Grid / Inverter Generator. Under this option, the frequency and phase of the Inverter Section are synchronized with the Grid as follows:

- i. First, the frequency of the Inverter Section is tracked in steps of 0.1Hz per cycle and made equal to the frequency of the Grid / Inverter Generator input.
- ii. Then, the phase of the Inverter voltage relative to the phase of the Grid / Inverter Generator voltage is tracked by 1° per cycle. When the phase of the Inverter voltage is within  $\pm 3.5^\circ$  of the input voltage waveform, the Transfer Relay is activated to transfer the AC load from the Grid / Inverter Generator to the Inverter Section at zero crossing of the voltage waveform.

## SECTION 4 | Parameter Setup

### 4.5.2.9.1 Programming Steps for Parameter "SYNC GEN"

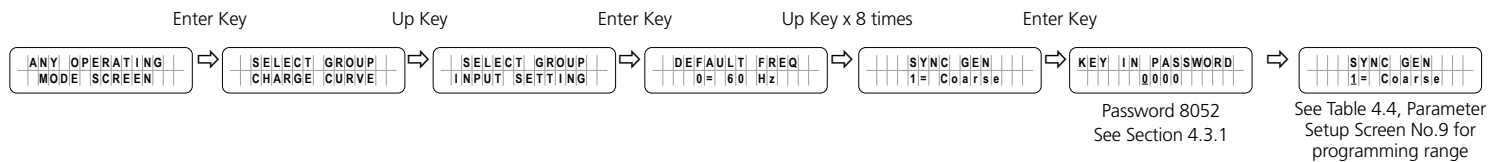

### 4.5.2.10 INPUT OC PROTECT (Table 4.4, Parameter Setup Screen No.10)

If the net AC input current is 1A more than the value of GRID MAX CURRENT (See Section 4.5.2.2) or GEN MAX CURRENT (See Section 4.5.2.3) for 1 sec, the AC side charging current is clawed back to ensure that GRID MAX CURRENT / GEN MAX CURRENT value is not exceeded. If the value of pass through load current increases to a value of 1A more than the programmed value of GRID MAX CURRENT / GEN MAX CURRENT for 5 sec, input over current protection will be activated based on the following 2 options provided through parameter **INPUT OC PROTECT**:

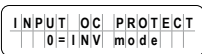
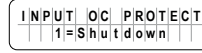
- a)  (This is the Default setting)
- o If the AC input current is 1A more than the programmed value of GRID MAX CURRENT / GEN MAX CURRENT for more than 5 sec, the unit will switch over to Inverter Mode to ensure that AC power to the load is maintained.
  - o If the load reduces to 1A less than the programmed value of GRID MAX CURRENT / GEN MAX CURRENT for 5 sec, switch back to Charging Mode
- b) 
- o If the AC input current is 1A more than the programmed value of GRID MAX CURRENT / GEN MAX CURRENT for more than 5 sec, Fault Mode will be activated:
    - There will be no AC output because the Transfer Relay will be de-energized, charging will be stopped and PWM drive to the Inverter Section will be switched off
    - Fault message "Input over current" will be displayed on the LCD screen, Green LED marked "Status" will be switched off and Red LED marked "Fault" will be switched on.
  - o The unit will be latched in OFF condition and will require manual reset by powering off the unit, waiting for 1 min and then, powering on again

### 4.5.2.10.1 Programming Steps for Parameter "OC PROTECT"

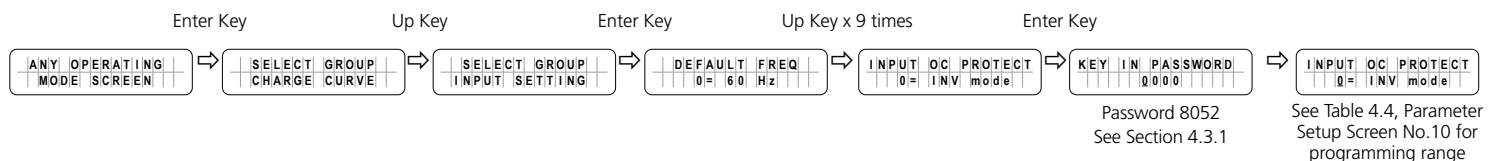

### 4.5.2.11 INPUT RECOVERY (Table 4.4, Parameter Setup Screen No.11)

This parameter determines how EVO™ will recover when AC input is made available while in "Battery low voltage!" or "Battery ultra low voltage!" fault conditions (Section 7, Table 7.1, Srl.2). The following 2 options are available under this parameter:

- Option "0=Buffered" (This is the default option)
- Option "1=Direct"



## SECTION 4 | Parameter Setup

When the EVO™ is in “Battery low voltage!” condition (*Section 7, Table 7.1, Srl.1*) or in “Battery ultra low voltage!” condition (*Section 7, Table 7.1, Srl.2*) and if AC input is made available before expiry of time set by parameter “LV CUT OFF TIME” (*Section 4.4.2.11*), the “Battery low voltage!” / “Battery ultra low voltage!” fault conditions will be cleared and EVO™ Inverter/Charger will recover based on the following 2 options:

- a) **Option 0=Buffered (Default):** Under this option, the unit will initially start in “Inverting Mode”, synchronize with the AC input and then transfer to “Charging Mode”. However, if a user programs the value of “BATTERY LOW VOLTAGE” very close to the “Battery ultra low voltage!” fault threshold of 9V for 1 ms for EVO-2212/3012/2212E/3012E or 18V for 1 ms for EVO-2224/4024/2224E/4024E (*Section 7, Table 7.1, Srl.2*), a larger load / larger starting surge on the inverter may drag the battery voltage to 9V / 18V or below for 1 ms and trigger “Battery ultra low voltage!” fault. Under this condition, the user may change to **Option 1=Direct**
- b) **Option 1=Direct:** Under this option, the unit will directly start in “Charging Mode”

### 4.5.2.11.1 Programming Steps for Parameter "INPUT RECOVERY"

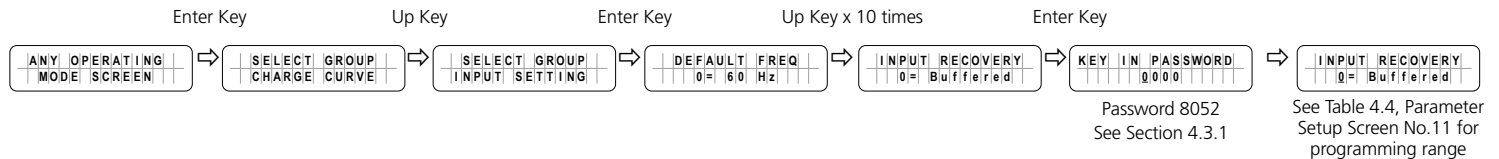

## 4.6 GROUP 3 PARAMETER SET UP: INPUT LOW LIMIT

### 4.6.1 Programming Ranges and Default Values of Parameters Under Group 3 – INPUT LOW LIMIT

Table 4.5 gives details of programming ranges and default values of parameters under Parameter Group 3 - INPUT LOW LIMIT. Refer to Fig 4.1 under Section 4.1 for Menu Map for navigating through various parameters under this Group 3.

TABLE 4.5 GROUP 3 PARAMETER SET UP: INPUT LOW LIMIT									
Parameter Setup Screen No. for Parameter Group No.3 (Fig 4.1)	Parameter	Programming Range/Options				Default Value			
		EVO-2212 / EVO-2212E	EVO-3012 / EVO-3012E	EVO-2224 / EVO-2224E	EVO-4024 / EVO-4024E	EVO-2212 / EVO-2212E	EVO-3012 / EVO-3012E	EVO-2224 / EVO-2224E	EVO-4024 / EVO-4024E
1	RESET VOLTAGE	60.0 – 120.0V / 140 - 200.0V				105.0V / 190.0V			
2	CUT OFF VOLT 1	60.0 – 120.0V / 140 - 200.0V				100.0V / 180.0V			
3	DETECT TIME 1	0 – 2000 cycles				300 cycles			
4	CUT OFF VOLT 2	60.0 – 120.0V / 140 - 200.0V				170.0V			
5	DETECT TIME 2	0 – 2000 cycles				60 cycle			
6	CUT OFF VOLT 3	60.0 – 120.0V / 140 - 200.0V				90.0V / 160.0V			
7	DETECT TIME 3	0 – 2000 cycles				1 cycle			

# SECTION 4 | Parameter Setup

## 4.6.2 Description of Parameters Under Group 3 – INPUT LOW LIMIT



INFO

The values shown under various screens are the Default Values for EVO-2212

### 4.6.2.1 RESET VOLTAGE (Table 4.5, Parameter Setup Screen No.1)

This is the reset voltage at which the unit will revert to "Charging Mode" after it has switched over to "Inverting Mode" due to input voltage falling to "CUT-OFF VOLT 1 (Section 4.6.2.2), or CUT-OFF VOLT 2 (Section 4.6.2.4), or CUT-OFF VOLT3" (Section 4.6.2.6).

#### 4.6.2.1.1 Programming Steps for Parameter "RESET VOLTAGE"

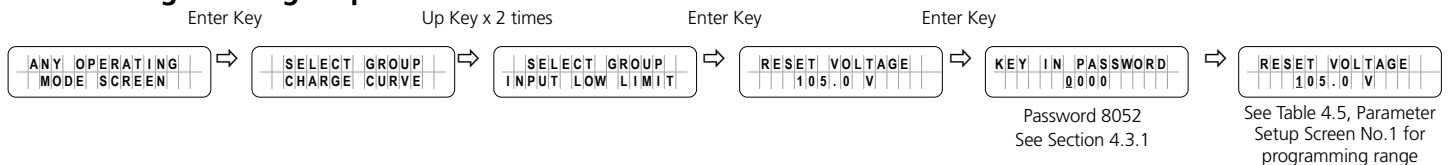

### 4.6.2.2 CUT OFF VOLT 1 (Table 4.5, Parameter Setup Screen No.2)

If during "Charging Mode", the AC input voltage falls below "CUT-OFF VOLT 1" for period > "DETECT TIME 1" (Section 4.6.2.3), the EVO™ Inverter/Charger will transfer to Inverting Mode from "Charging Mode".

#### 4.6.2.2.1 Programming Steps for Parameter "CUT OFF VOLT 1"

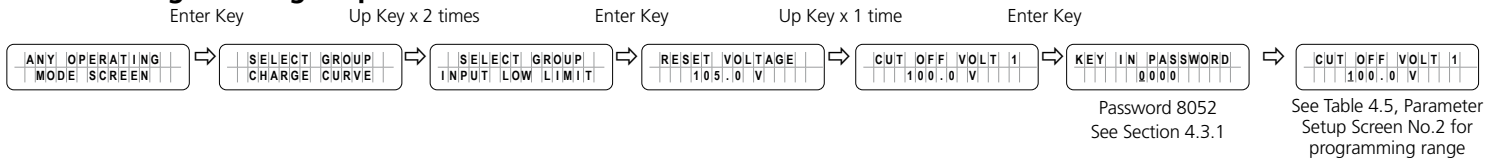

### 4.6.2.3 DETECT TIME 1 (Table 4.5, Parameter Setup Screen No.3)

This is the time limit in cycles up to which low AC input voltage "CUT-OFF VOLT 1" (Section 4.6.2.2) is allowed.

#### 4.6.2.3.1 Programming Steps for Parameter "DETECT TIME 1"

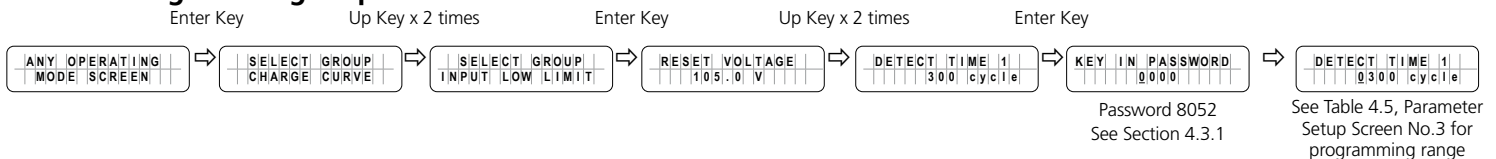

### 4.6.2.4 CUT OFF VOLT 2 (Table 4.5, Parameter Setup Screen No.4)

If during "Charging Mode", the AC input voltage falls below "CUT-OFF VOLT 2" for period > "DETECT TIME 2" (Section 4.6.2.5), the EVO™ Inverter/Charger will transfer to "Inverting Mode".

#### 4.6.2.4.1 Programming Steps for Parameter "CUT OFF VOLT 2"

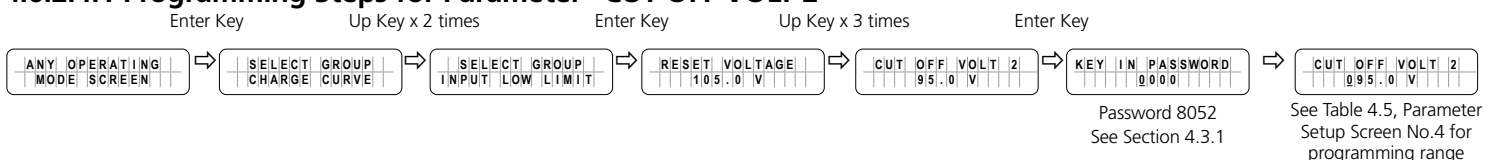

## SECTION 4 | Parameter Setup

### 4.6.2.5 DETECT TIME 2 (Table 4.5, Parameter Setup Screen No.5)

This is the time limit in cycles up to which low AC input voltage "CUT-OFF VOLT 2" (Section 4.6.2.4) is allowed.

#### 4.6.2.5.1 Programming Steps for Parameter "DETECT TIME 2"

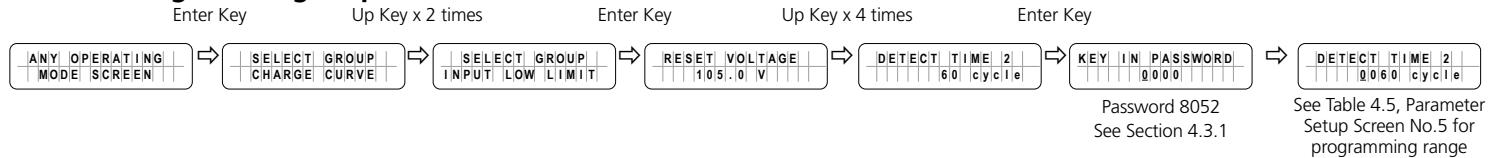

### 4.6.2.6 CUT OFF VOLT 3 (Table 4.5, Parameter Setup Screen No.6)

If during "Charging Mode", the AC input voltage falls below "CUT-OFF VOLT 3" for period > "DETECT TIME 3" (Section 4.6.2.7), the EVO™ Inverter/Charger will transfer to "Inverting Mode".

#### 4.6.2.6.1 Programming Steps for Parameter "CUT OFF VOLT 3"

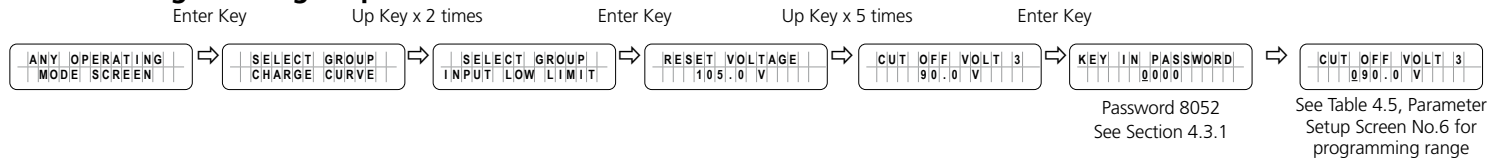

### 4.6.2.7 DETECT TIME 3 (Table 4.5, Parameter Setup Screen No.7)

This is the time limit in cycles up to which low AC input voltage "CUT-OFF VOLT 3" (Section 4.6.2.6) is allowed.

#### 4.6.2.7.1 Programming Steps for Parameter "DETECT TIME 3"

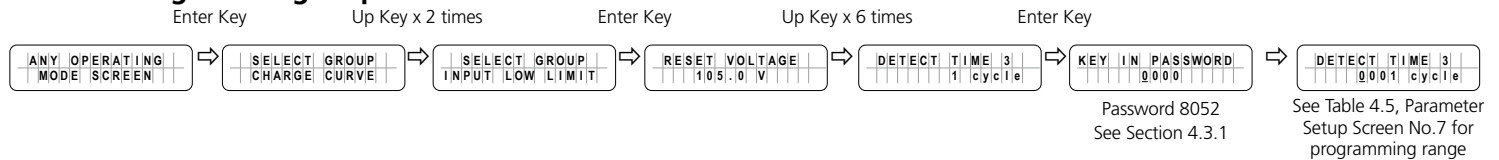

## 4.7 GROUP 4 PARAMETER SET UP: INPUT HIGH LIMIT

### 4.7.1 Programming Ranges and Default/ Factory Preset Values of Parameters Under Group 4 – INPUT HIGH LIMIT

Table 4.6 gives details of programming ranges and default values of parameters under Parameter Group 4 - INPUT HIGH LIMIT. Refer to Fig 4.1 under Section 4.1 for Menu Map for navigating through various parameters under this Group 4.

## SECTION 4 | Parameter Setup

**TABLE 4.6 GROUP 4 PARAMETER SET UP: INPUT HIGH LIMIT**

Parameter Setup Screen No. for Parameter Group No.4 <i>(Fig 4.1)</i>	Parameter	Programming Range				Default Value			
		EVO-2212 / EVO-2212E	EVO-3012 / EVO-3012E	EVO-2224 / EVO-2224E	EVO-4024 / EVO-4024E	EVO-2212 / EVO-2212E	EVO-3012 / EVO-3012E	EVO-2224 / EVO-2224E	EVO-4024 / EVO-4024E
1	RESET VOLTAGE	120.0 – 150.0V / 200.0 – 280.0V				125.0V / 360.0V			
2	CUT OFF VOLT 1	120.0 – 150.0V / 200.0 – 280.0V				135.0V / 265.0V			
3	DETECT TIME 1	0 – 2000 cycle				60 cycle			
4	CUT OFF VOLT 2	120.0 – 150.0V / 200.0 – 280.0V				140.0V / 270.0V			
5	DETECT TIME 2	0 – 2000 cycle				15 cycle			
6	CUT OFF VOLT 3	120.0 – 150.0V / 200.0 – 280.0V				145.0V / 275.0V			
7	DETECT TIME 3	0 – 2000 cycle				1 cycle			

### 4.7.2 Description of Parameters Under Group 4 – INPUT HIGH LIMIT



The values shown under various screens are the Default Values for EVO-2212

#### 4.7.2.1 RESET VOLTAGE *(Table 4.6, Parameter Setup Screen No.1)*

This is the reset voltage at which the unit will revert to "Charging Mode" after it has switched over to "Inverting Mode" due to input voltage falling to "CUT-OFF VOLT 1" *(Section 4.7.2.2)*, or CUT-OFF VOLT 2 *(Section 4.7.2.4)*, or CUT-OFF VOLT3" *(Section 4.7.2.6)*.

##### 4.7.2.1.1 Programming Steps for Parameter "RESET VOLTAGE"

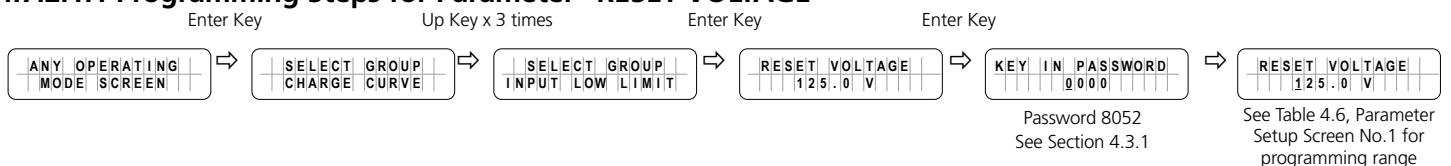

#### 4.7.2.2 CUT OFF VOLT 1 *(Table 4.6, Parameter Setup Screen No.2)*

If during "Charging Mode", the AC input voltage falls below "CUT-OFF VOLT 1" for period > "DETECT TIME 1" *(Section 4.7.2.3)*, the EVO™ Inverter/Charger will transfer to Inverting Mode.

##### 4.7.2.2.1 Programming Steps for Parameter "CUT OFF VOLT 1"

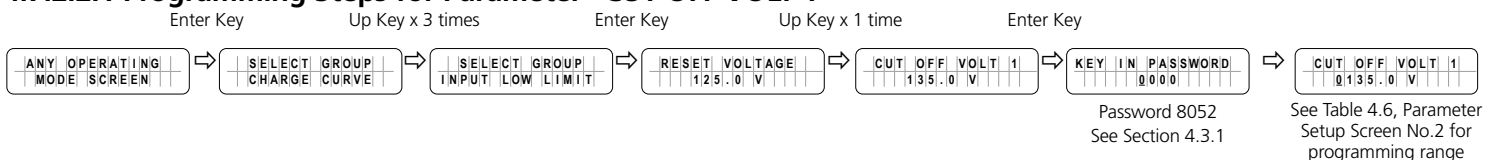

#### 4.7.2.3 DETECT TIME 1 *(Table 4.6, Parameter Setup Screen No.3)*

This is the time limit in cycles up to which low AC input voltage "CUT-OFF VOLT 1" *(Section 4.7.2.2)* is allowed.

# SECTION 4 | Parameter Setup

## 4.7.2.3.1 Programming Steps for Parameter "DETECT TIME 1"

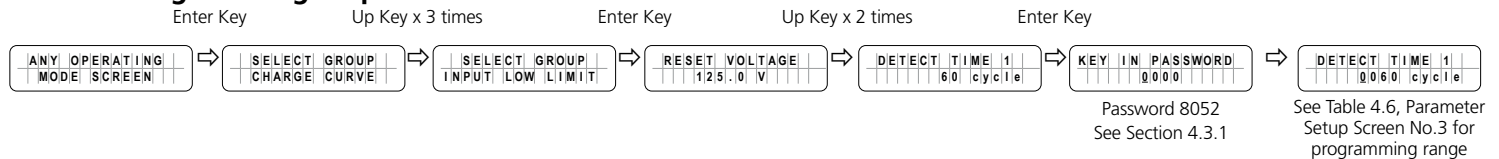

## 4.7.2.4 CUT OFF VOLT 2 (Table 4.6, Parameter Setup Screen No.4)

If during "Charging Mode", the AC input voltage falls below "CUT-OFF VOLT 2" for period > "DETECT TIME 2" (Section 4.7.2.5), the EVO™ Inverter/Charger will transfer to "Inverting Mode".

### 4.7.2.4.1 Programming Steps for Parameter "CUT OFF VOLT 2"

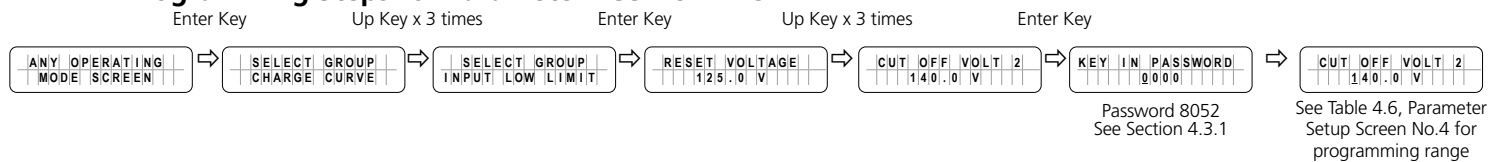

## 4.7.2.5 DETECT TIME 2 (Table 4.6, Parameter Setup Screen No.5)

This is the time limit in cycles up to which low AC input voltage "CUT-OFF VOLT 2" (Section 4.7.2.4) is allowed.

### 4.7.2.5.1 Programming Steps for Parameter "DETECT TIME 2"

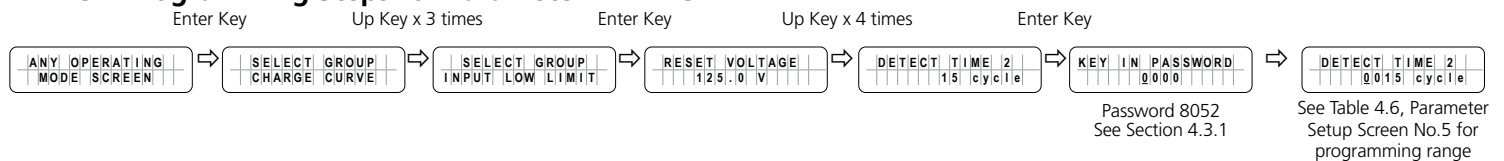

## 4.7.2.6 CUT OFF VOLT 3 (Table 4.6, Parameter Setup Screen No.6)

If during "Charging Mode", the AC input voltage falls below "CUT-OFF VOLT 3" for period > "DETECT TIME 3" (Section 4.7.2.7), the EVO™ Inverter/Charger will transfer to "Inverting Mode".

### 4.7.2.6.1 Programming Steps for Parameter "CUT OFF VOLT 3"

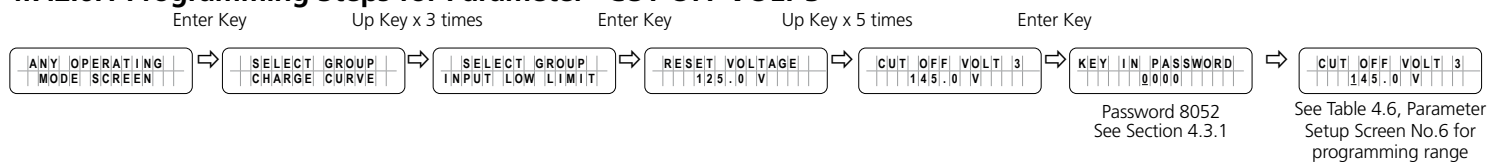

## 4.7.2.7 DETECT TIME 3 (Table 4.6, Parameter Setup Screen No.7)

This is the time limit in cycles up to which low AC input voltage "CUT-OFF VOLT 3" (Section 4.7.2.6) is allowed.

### 4.7.2.7.1 Programming Steps for Parameter "DETECT TIME 3"

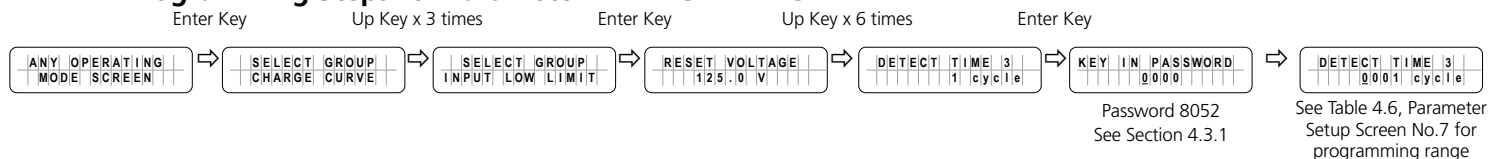

## SECTION 4 | Parameter Setup

### 4.8 GROUP 5 PARAMETER SET UP: OTHER FUNCTIONS

#### 4.8.1 Programming Ranges and Default/ Factory Preset Values of Parameters Under Group 5 – OTHER FUNCTION

Table 4.7 gives details of programming ranges and default values of parameters under Parameter Group 5 - OTHER FUNCTION. *Refer to Fig 4.2 under Section 4.1 for Menu Map for navigating through various parameters under this Group 5.*

TABLE 4.7 GROUP 5 PARAMETER SET UP: OTHER FUNCTIONS									
Parameter Setup Screen No. for Parameter Group No.5 <i>(Fig 4.2)</i>	Parameter	Programming Range/Options				Default Value			
		EVO-2212 / EVO-2212E	EVO-3012 / EVO-3012E	EVO-2224 / EVO-2224E	EVO-4024 / EVO-4024E	EVO-2212 / EVO-2212E	EVO-3012 / EVO-3012E	EVO-2224 / EVO-2224E	EVO-4024 / EVO-4024E
1	POWER SAVING	1 = Enable 0 = Disable				0 = Disable			
2	ENTER POINT	4 – 50W				6W	8W	6W	8W
3	WAKE UP POINT	5 – 50W				7W	10W	7W	10W
4	REMOTE SWITCH	0 = Button Type 1 = Switch Type				Button type			
5	RELAY FUNCTION	0 = Charge/Other 1 = Normal/Fault 2 = Generator 0 3 = Generator 1 4 = Generator 2				2 = Generator 0			
6	COMM ID	1 – 255				1			
7	BUZZER	1 = ON 0 = OFF				1 = ON			
8	DISCHARGE BEEP	1 = ON 0 = OFF				0 = OFF			
9	DEFAULT RESET	0 = No 1 = Yes				0 = No			
10	DATALOG DISABLE DATALOG TIME	0 = Disable, 1 = 1 sec, 2 = 10 sec, 3 = 30 sec 4 = 1 min, 5 = 5 min, 6 = 10 min				1 = 1 sec			
11	PARAMETER SAVE	0 = No 1 = Yes				0 = No			
12	TEMP UNIT	0 = °C 1 = °F				0 = °C			
13	PASSWORD DISABLE	0 = No 1 = Yes				0 = No			

# SECTION 4 | Parameter Setup

## 4.8.2 Description of Parameters Under Group 5 – OTHER FUNCTION



INFO

The values shown under various screens are the Default Values for EVO-2212/2212E

### 4.8.2.1 POWER SAVING (Table 4.7, Parameter Setup Screen No.1)



INFO

For more information on use and application of Power Save Functions, please refer to Sections 4.8.3 & 4.8.4 in the attached "EVO™ Owner's Manual."

Parameter "POWER SAVING" is used to enable or disable Power Saving Mode when in "Inverting Mode".

#### 4.8.2.1.1 Programming Steps for Parameter "POWER SAVING"

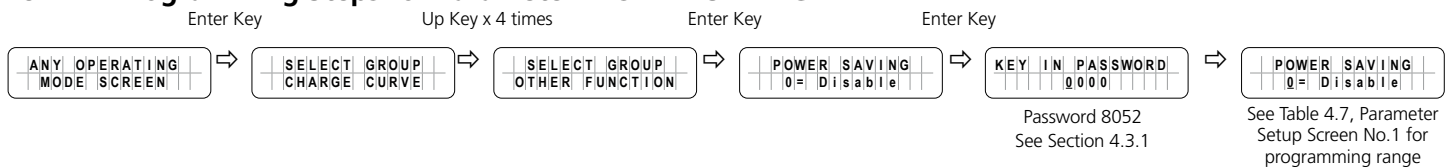

#### 4.8.2.2 ENTER POINT (Table 4.7, Parameter Setup Screen No.2)

If the value of power drawn by AC load falls to the "ENTER POINT" value for 5 sec, the unit will enter "Power Save Mode" (Section 4.8.2.1).

#### 4.8.2.2.1 Programming Steps for Parameter "ENTER POINT"

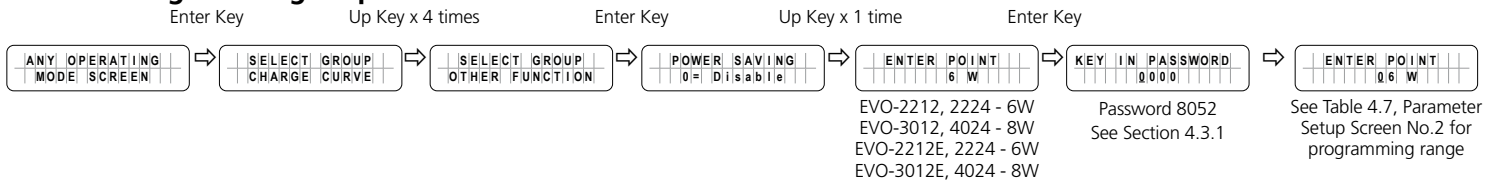

#### 4.8.2.3 WAKE UP POINT (Table 4.7, Parameter Setup Screen No.3)

If the unit is in "Power Save Mode" (Section 4.8.2.1) and the value of the AC power of the load rises to "WAKE UP POINT", the unit will quit "Power Save Mode" and will start operating in full voltage "Inverting Mode".

#### 4.8.2.3.1 Programming Steps for Parameter "WAKE UP POINT"

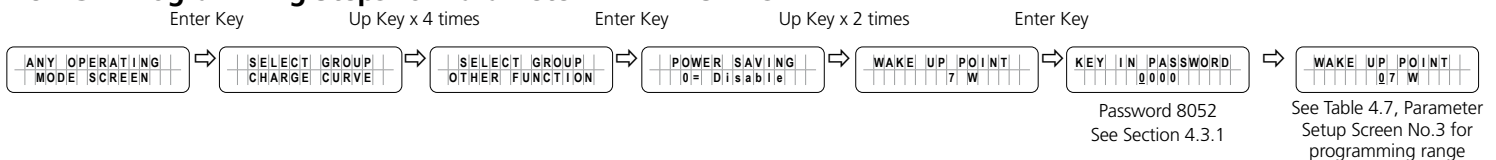

#### 4.8.2.4 REMOTE SWITCH (Table 4.7, Parameter Setup Screen No.4)

This parameter is used when ON/OFF control of EVO™ Inverter/Charger is desired through external 12 VDC signal fed to terminals marked "Remote ON/OFF" on the Front Panel of EVO™ Inverter/Charger (15, Fig 2.1 in the EVO™ Owner's Manual).

## SECTION 4 | Parameter Setup

On/Off Logic Diagram is shown in Fig 4.4 below:

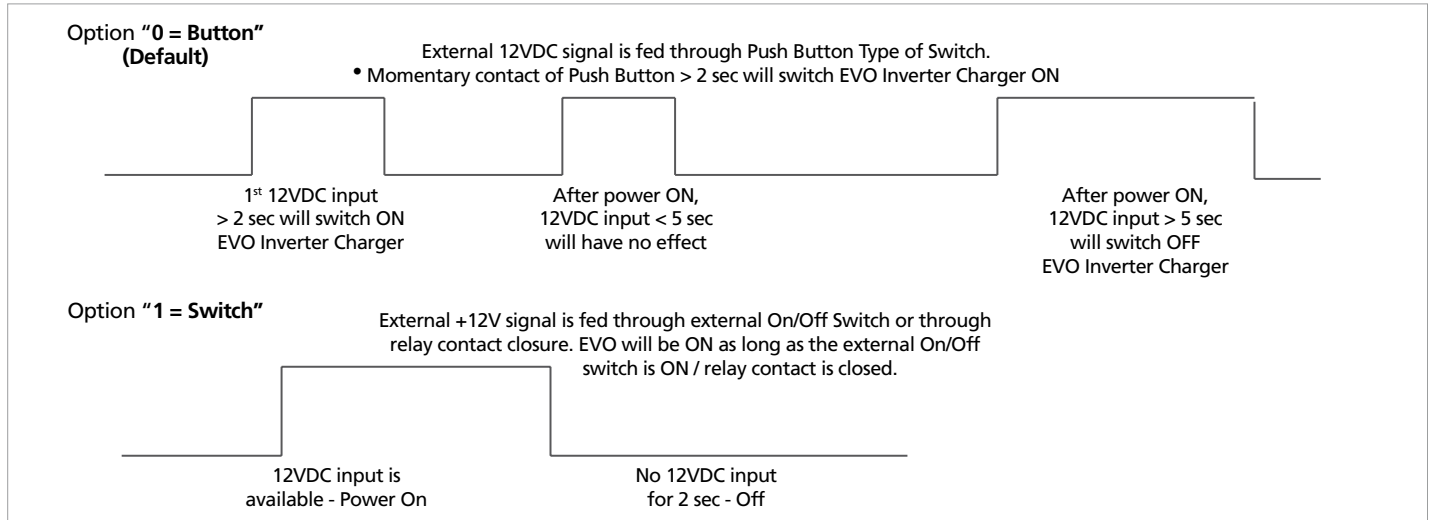

Fig 4.4. On/Off Logic Diagram for Options under Parameter "REMOTE SWITCH"



### CAUTION!

On/Off Logic shown in Fig 4.4 also controls the operation of the On/Off Button on the front panel of EVO™ Inverter/Charger (11, Fig 2.1 in the EVO™ Owner's Manual). The Default Setting is "Button Type". If parameter "REMOTE SWITCH" is set to option "1=Switch", the normal On/Off operation of EVO™ using the front panel On/Off Button (Section 3.2) will be disrupted i.e. EVO™ will remain on as long as the On/Off Button is kept pressed and will switch Off when the Button is released (See logic diagram for Option "1=Switch" in Fig 4.4)



### ATTENTION!

Logique On / Off montré dans la figure 4,4 contrôle également le fonctionnement du bouton ON/OFF sur le panneau d'avant de l'onduleur chargeur de l' EVO™ (11, Fig 2.1 dans le manuel du propriétaire EVO™). Le réglage par défaut est « Button Type ». Si le paramètre "REMOTE SWITCH" ; est définie à l'option « 1 =Switch, le fonctionnement marche/arrêt normal d'EVO™ à l'aide du panneau avant sur le bouton marche/arrêt (Section 3.2) sera perturbé, c. à-EVO™ reste allumé aussi longtemps que le bouton marche/arrêt est enfoncé et s'éteint lorsque le bouton est relâché (voir schéma logique pour l'option « 1 =Switch" ; dans la Figure 4.4)



## SECTION 4 | Parameter Setup

### 4.8.2.4.1 Programming Steps for Parameter "REMOTE SWITCH"

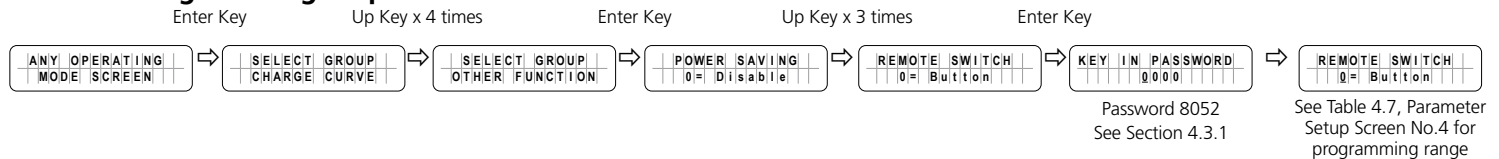

### 4.8.2.5 RELAY FUNCTION *(Table 4.7, Parameter Setup Screen No.5)*

A Single Pole Double Throw (SPDT) Status Relay with 3 contacts (*Contact Rating: 3A ; 125 VAC / 30 VDC*) has been provided that is used for (i) signaling of operational status [*Options 0 and 1 - see Section 4.8.2.5.1(a)*] and (ii) providing contact closure / opening for automatic starting and stopping of generator through appropriate optional Generator Auto Start / Stop Control Module [*Options 2, 3 and 4 - see Section 4.8.2.5.2(a) to (c)*]. The 3 contacts of the Status Relay are connected to 3 terminals of Terminal Block (14, *Fig 2.1 in the EVO™ Owner's Manual*) on the front panel. The contacts are marked "NO" (*Normally Open*), "Common" and "NC" (*Normally Closed*). When the Status Relay is OFF (*de-energized*), contacts marked "Common" and "NO" will be in open condition and contacts marked "Common" and "NC" will be in closed condition. When the Status Relay is ON (*energized*), contacts marked "Common" and "NO" will close and contacts marked "Common" and "NC" will open.

Diagram showing steps for programming the "RELAY FUNCTION" (*Table 4.7, Parameter Setup Screen No.5*) and details of 5 different associated Options 0 to 4 are provided in the succeeding paragraphs

#### 4.8.2.5.1 Signaling of Operational States (Options 0 and 1)

- a) **Option"0 = Charger/Other"**: When the EVO™ Inverter/Charger is in "Charging" Mode, the Status Relay will be OFF (*de-energized*) [*(i) "Common" and "NO" contacts will be in open condition and (ii) "Common" and "NC" contacts will be in closed condition*]. In "Other" operating modes i.e. in "Inverting", "Power Save" or in "Standby" Modes, the Status Relay will be ON (*energized*) [*(i) Common and "NO" contacts will close and (ii) "Common" and "NC" contacts will open*]
- b) **Option"1= Normal/Fault"**: When in "Normal" operational state i.e. when not in Fault Mode, the Status Relay will be OFF (*de-energized*) [*(i) "Common" and "NO" contacts will be in open condition and (ii) "Common" and "NC" contacts will be in closed condition*]. When the EVO™ Inverter/Charger is in "Fault" mode (*Section 7, Table 7.1*), the Status Relay will be ON (*energized*) [*(i) Common and "NO" contacts will close and (ii) "Common" and "NC" contacts will open*].



#### INFO

A 12V, 100 mA capacity DC source has been provided in the main EVO™ unit (*16 in Fig 2.1 of the EVO™ Owner's Manual*). This 12V DC source may be used to drive 12V rated signalling device through the contacts of the Status Relay for the above 2 options (*Options 0 & 1*)

#### 4.8.2.5.2 Automatic Starting and Stopping of Generator (Options 2, 3 and 4)

The Normally Open "NO" and "Common" contacts of Status Relay (*14, Fig 2.1 in the EVO™ Owner's Manual*) can be used to also automatically start and stop generator through appropriate external Generator Auto Start / Stop Module. 3 options [*Options 2, 3 and 4 - see Sections 4.8.2.5.2.1 to 4.8.2.5.2.3*] are available for carrying out this function depending upon user requirements. The "Common" and "NO" terminals are wired to the optional Generator Auto Start / Stop Control Module which, in turn, is wired to the Remote Start / Stop connections on the Generator. The AC

## SECTION 4 | Parameter Setup

output terminals of the Generator are wired to the Generator Input Terminals on the EVO™ (7, 8, 9 in Fig 2.3 in the EVO™ Owner's Manual). For installation details, please refer to Section 3.17 / Fig 3.14 and Section 3.18 / Fig 3.15A & B in the EVO™ Owner's Manual.



It is recommended that "GSCM-Mini" Series of Generator Start / Stop Control Module, appropriate for the generator may be considered and ordered directly from Atkinson Electronics [www.atkinsonelectronics.com](http://www.atkinsonelectronics.com)

Based on the Generator Start Logic contained in one of the selected Options 2, 3 or 4 explained below (See Sections 4.8.2.5.2.1 to 4.8.2.5.2.3), the Status Relay will be switched ON (*energized*), its "Common" and "NO" contacts will close and the external Generator Start / Stop Control Module will initiate automatic starting of the Generator. Once the Generator has started and starts feeding AC output to EVO™ (*within the programmed limits of voltage and frequency*), the EVO™ will be synchronized with the Generator and once synchronization is completed, the load will be transferred instantly (*within 1 ms*) to the Generator at Zero Crossing of the voltage waveform for seamless transfer and for better protection of Transfer Relay contacts. The EVO™ will now operate in "Charging Mode" with the AC power from the Generator charging the batteries as well as providing power to the AC load(s).

Based on the Generator Stop Logic contained in one of the selected Options 2, 3 or 4 explained below (See Sections 4.8.2.5.2.1 to 4.8.2.5.2.3), the Status Relay will be switched OFF (*de-energized*), its "Common" and "NO" contacts will open and the external Generator Auto Start Control Control Module will initiate automatic stopping of the Generator. When AC output of the generator is shut down, the EVO™ will automatically transfer the AC load(s) to the "Inverter Section" within 16 ms.

Options 2, 3 and 4 of Parameter "RELAY FUNCTION" related to automatic starting and stopping of generator are explained below under Sections 4.8.2.5.2.1 to 4.8.2.5.2.3:

### 4.8.2.5.2.1 Option 2= Generator 0 (This is the Default Option):

This option will start the Generator at "LOW VOLT ALARM" (Section 4.4.2.8) and stop the Generator when the batteries are charged based on the charging profile selected through programming parameter "CHARGING PROFILE" (Section 4.4.2.21).

Further details are given below:

- If the battery voltage drops to "LOW VOLT ALARM" (Section 4.4.2.8) for continuous period that has been set by parameter "GS DETECT TIME" (Section 4.4.2.16), the Status Relay will be energized. "Common" and "NO" contacts of the Status Relay will close to initiate automatic starting of the Generator
- Once the generator has started and starts feeding AC output (*within the programmed limits of voltage and frequency*), the EVO™ will change over from "Inverting Mode" to "Charging Mode". Battery charging will be initiated as per the charging profile set through parameter "CHARGING PROFILE" (Section 4.4.2.21)
- Charging will be carried out till the batteries are charged as follows and then, the Status Relay will be de-energized to stop the generator:
  - For Parameter "CHARGING PROFILE" (Section 4.4.2.21) set for 3 Stage Charging Profile as per (i) "Option 0 = 3 Stage Type 0", (ii) Option "1 = 3 Stage Type 1" and (iii) Option "2 = 3 Stage Type 2"

## SECTION 4 | Parameter Setup

- The Status Relay will be de-energized to stop the Generator as soon as the battery bank is charged to the voltage threshold set by parameter "FLOATING VOLTAGE" ([Section 4.4.2.4](#))
- For Parameter "CHARGING PROFILE" (Section 4.4.2.21) set for 2 Stage Charging Profile as per "Option "3 = 2 Stage Type 1"
  - The Status Relay will be de-energized to stop the Generator when the battery bank is charged to voltage threshold set by parameter "ABSORP VOLTAGE" ([Section 4.4.2.2](#)) and remains at this level for time period set by parameter "ABSORP TIME" ([Section 4.4.2.19](#))
- For Parameter "CHARGING PROFILE" (Section 4.4.2.21) set for 2 Stage Charging Profile as per "Option "4 = 2 Stage Type 2"
  - The Status Relay will be de-energized to stop the Generator when the battery bank is charged to voltage threshold set by parameter "ABSORP VOLTAGE" ([Section 4.4.2.2](#)) and remains at this level for time period of 6 min
- For Parameter "CHARGING PROFILE" (Section 4.4.2.21) set for 2 Stage Charging Profile as per "Option "3 = 2 Stage Type 3"
  - The Status Relay will be de-energized to stop the Generator when the battery bank is charged to voltage threshold set by parameter "ABSORP VOLTAGE" ([Section 4.4.2.2](#)) and subsequently, the charging current drops to threshold set by parameter "ABSORP EXIT AMPS" ([Section 4.4.2.20](#))

When the Status Relay is de-energized, "Common" and "NO" contacts of the Status Relay will open to initiate automatic stopping of the Generator. When AC output voltage from the Generator switches off, the EVO™ will change over to "Inverting Mode".

### 4.8.2.5.2.2 Option 3= Generator 1

This option will start the Generator at "LOW VOLT ALARM" ([Section 4.4.2.8](#)) and stop the Generator when the batteries are charged to the desired programmed level of "RESET VOLTAGE" ([Section 4.4.2.7](#)) and stay at this desired level of voltage or higher for the desired programmed time period = "GEN OFF DELAY" ([Section 4.4.2.18](#)).

Further details are given below:

- If the battery voltage drops to "LOW VOLT ALARM" ([Section 4.4.2.8](#)) or lower for continuous period = "GS DETECT TIME" ([Section 4.4.2.16](#)), the Status Relay will be switched ON (energized). "Common" and "NO" contacts of the Status Relay will close to initiate automatic starting of the Generator
- Once the generator has started and starts feeding AC output (within the programmed limits of voltage and frequency), the EVO™ will change over from "Inverting Mode" to "Charging Mode". Battery charging will be initiated as per Charging Profile set by parameter "CHARGING PROFILE" ([Section 4.4.2.21](#)).
- When the batteries are charged to the desired voltage level set by parameter "RESET VOLTAGE" ([Section 4.4.2.7](#)) and stay at this desired level of voltage, or higher for the desired programmed time period = "GEN OFF DELAY" ([Section 4.4.2.18](#)), the Status Relay will be switched OFF (de-energized). "Common" and "NO" contacts of the Status Relay will open to initiate automatic stopping of the Generator. When AC output from the Generator switches OFF, EVO™ will change over to "Inverting Mode" (**NOTE: The State of Charge of the battery after the Status Relay has been switched OFF (de-energized) and Generator is stopped will be indeterminate.**)

# SECTION 4 | Parameter Setup

## 4.8.2.5.2.3 Option 4= Generator 2

This option will start the Generator at "LOW VOLT ALARM" (Section 4.4.2.8) and stop the Generator after the desired programmed value of run time of the Generator = "GEN ON TIME" (Section 4.4.2.17) counted from the time the Status Relay is switched ON (*energized*).

Further details are given below:

- If the battery voltage drops to "LOW VOLT ALARM" (Section 4.4.2.8), or lower for continuous period = "GS DETECT TIME" (Section 4.4.2.16), the Status Relay will be switched ON (*energized*). "Common" and "NO" contacts of the Status Relay will close to initiate automatic starting of the Generator
- Once the generator has started and starts feeding AC output (*within the programmed limits of voltage and frequency*), the EVO™ will change over from "Inverting Mode" to "Charging Mode". Battery charging will be initiated as per the charging profile set by parameter "CHARGING PROFILE" (Section 4.4.2.21)
- The Status Relay will be switched OFF (*de-energized*) after expiry of the desired programmed Generator run time = "GEN ON TIME" (Section 4.4.2.17) counted from the time the Status Relay is switched ON (*energized*). "Common" and "NO" contacts of the Status Relay will open to initiate automatic stopping of the Generator. When AC output from the Generator switches OFF, EVO™ will change over to "Inverting Mode" (*NOTE: The State of Charge of the battery after the Status Relay has been switched OFF (de-energized) and Generator is stopped will be indeterminate.*)

## 4.8.2.5.3 Programming Steps for Parameter "RELAY FUNCTION"

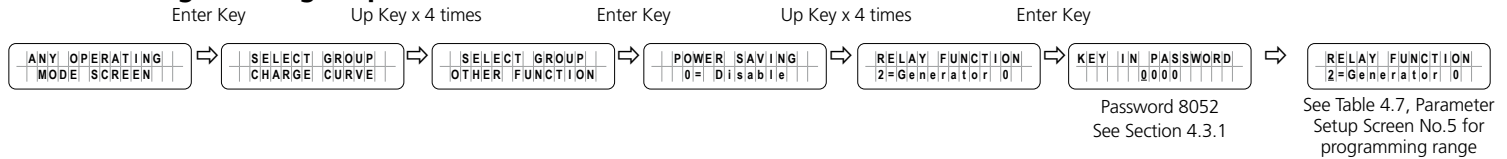

## 4.8.2.6 COMM ID (Table 4.7, Parameter Setup Screen No.6)

Communication ID- This sets the ID number for the COMM Port and EVO-RC Remote Control.

### 4.8.2.6.1 Programming Steps for Parameter "COMM ID"

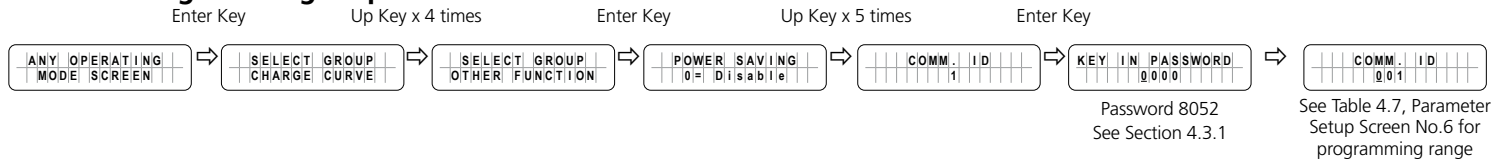

## 4.8.2.7 BUZZER (Table 4.7, Parameter Setup Screen No.7)

An audio alarm buzzer is located inside the EVO™ Inverter/Charger to provide pulsing or continuously beeping alarm based on operating conditions detailed in Table 6.1 under Section 6.

Parameter "BUZZER" provides option to switch on/ switch off the buzzer. The default option is "1=On".

### 4.8.2.7.1 Programming Steps for Parameter "BUZZER"

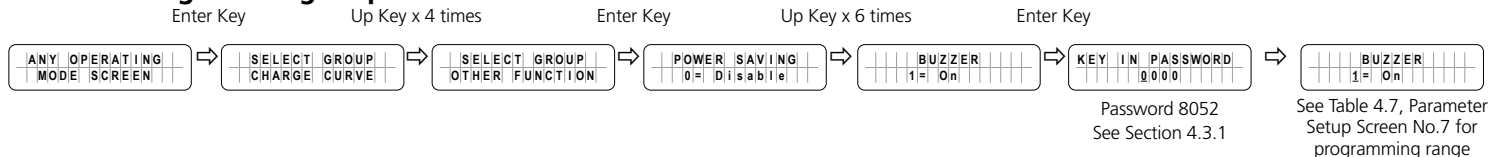

# SECTION 4 | Parameter Setup

## 4.8.2.8 DISCHARGE BEEP *(Table 4.7, Parameter Setup Screen No.8)*

When EVO™ Inverter/Charger is operating in "Inverting Mode", the batteries will be discharging. An audio alarm buzzer has been provided inside the EVO™ Inverter/Charger that will provide pulsing beep once every 3 sec to signal discharging of batteries under "Inverting Mode" *(Refer to Table 6.1 in Section 6)*.

Parameter "DISCHARGE BEEP" provides option to switch on/ switch off this alarm signalling. The default option is "1=On".

**NOTE:** If parameter "BUZZER" *(Section 4.8.2.7)* is set for option "0=Off", the operation of the buzzer will be switched off and there will be no discharge beeping even if parameter "DISCHARGE BEEP" has been set for option "1=On".

### 4.8.2.8.1 Programming Steps for Parameter "DISCHARGE BEEP"

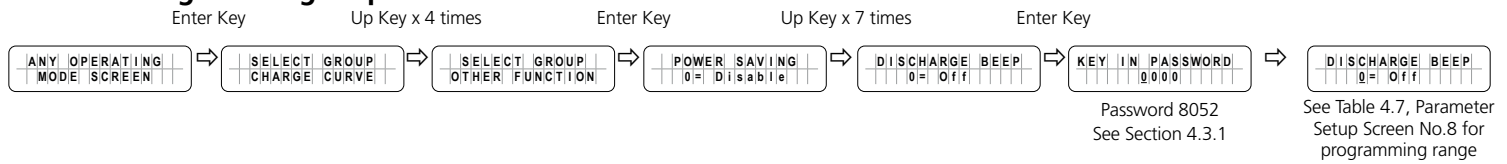

## 4.8.2.9 DEFAULT RESET *(Table 4.7, Parameter Setup Screen No.9)*

This is to reset all of the parameters to the Default Values.

### 4.8.2.9.1 Programming Steps for Parameter "DEFAULT RESET"

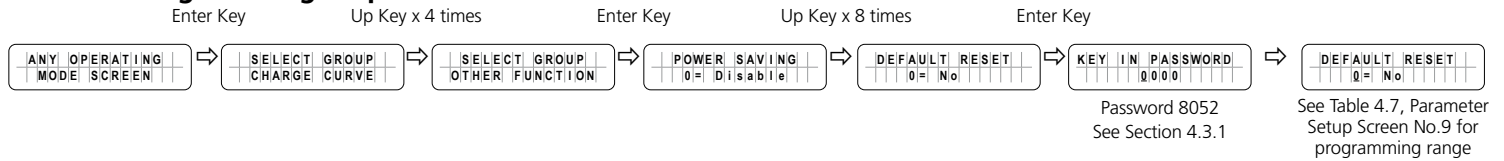

## 4.8.2.10 DATALOG TIME *(Table 4.7, Parameter Setup Screen No.10)*

Refer to Sections 5.2 and 5.3 on Data Logging

Data Logging uses external SD Card *(FAT 16/32, up to 32 GB capacity)* to record the values of various Operating Parameters /Events/Errors with Date and Time stamp controlled by an internal Real Time Clock (RTC). Parameters/ Events/Errors are recorded under "Data Logging Fields" *(Section 5.2.2 for information on Data Logging Fields)*.

The recorded values of the various Operating Parameters are their "Average Values" computed from "Instantaneous Values" scanned over a programmable "time interval" set by programming parameter "DATALOG TIME". Events / Errors are recorded as soon as they are sensed.

Apart from providing 6 options for setting the "time interval" for computing the "Average Values", programming parameter "DATALOG TIME" is also used to disable Data Logging by selecting programming option "0=Disable"

Programming Options: (i) 0=Disable, (ii) 1=1 sec (Default), (iii) 2=10sec, (iv) 3=30sec, (v) 4=60sec, (vi) 5=5min, (vii) 6=10min

### 4.8.2.10.1 Programming Steps for Parameter "DATALOG TIME"

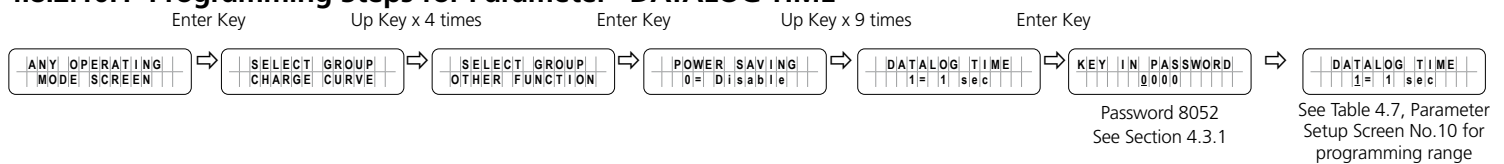

## SECTION 4 | Parameter Setup

### 4.8.2.11 PARAMETER SAVE *(Table 4.7, Parameter Setup Screen No.11)*

Save all parameters to SD Card. *(See Details at Section 5.4)*

#### 4.8.2.11.1 Programming Steps for Parameter "PARAMETER SAVE"

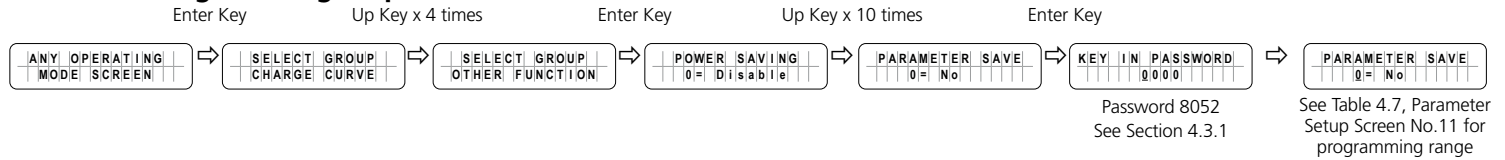

### 4.8.2.12 TEMP UNIT *(Table 4.7, Parameter Setup Screen No.12)*

Temperature can be displayed in °C or in °F. Default is in °C.

#### 4.8.2.12.1 Programming Steps for Parameter "TEMP UNIT"

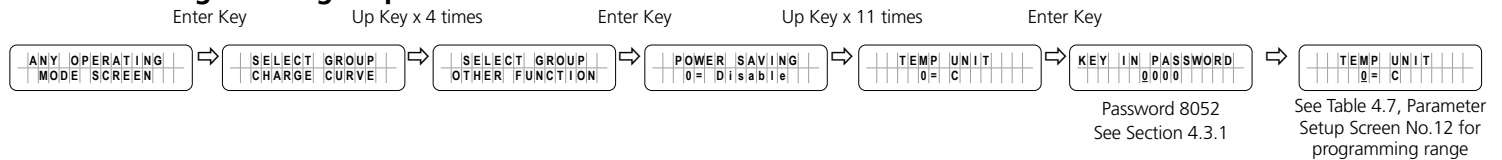

### 4.8.2.13 PASSWORD DISABLE *(Table 4.7, Parameter Setup Screen No.13)*

This parameter allows to disable/ enable Password (8052) to change the value of any programming parameter. Use of Password is recommended because it prevents accidental / un-intentional change of parameter setting. Default is enabled (*PASSWORD DISABLE set at option "0=No"*)

#### 4.8.2.13.1 Programming Steps for Parameter "PASSWORD DISABLE"

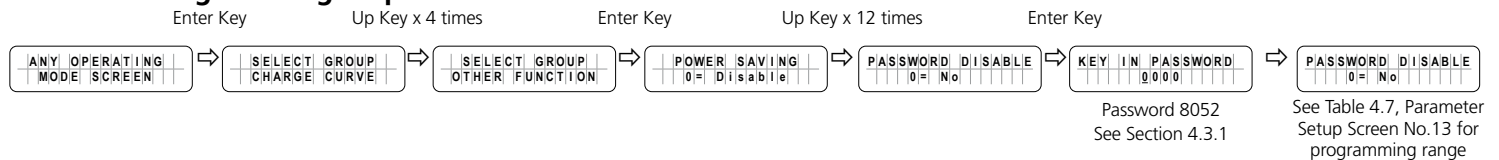

## 4.9 GROUP 6 PARAMETER SET UP: RC SETTING *(Section 4.1, Fig 4.2, Group 6)*

### 4.9.1 Programming Ranges and Default/ Factory Preset Values of Parameters Under Group 6 – RC SETTING

Table 4.8 gives details of programming ranges/ options and default values of 3 parameters under Parameter Group 6 - RC SETTING. *Refer to Fig 4.2 under Section 4.1 for Menu Map for navigating through various parameters under this Group 6.*

These parameters are used to control dimming of LCD back lighting of Remote Control EVO-RC.

# SECTION 4 | Parameter Setup

TABLE 4.8 GROUP 6 PARAMETER SET UP: RC SETTING									
Parameter Setup Screen No. for Parameter Group No.6 <i>(Fig 4.1)</i>	Parameter	Programming Range/Options				Default Option			
		EVO-2212 / EVO-2212E	EVO-3012 / EVO-3012E	EVO-2224 / EVO-2224E	EVO-4024 / EVO-4024	EVO-2212 / EVO-2212E	EVO-3012 / EVO-3012E	EVO-2224 / EVO-2224E	EVO-4024 / EVO-4024E
1	<b>ACTIVE LCD LIGHT</b>	0 = 0% 1 = 25%	2 = 50% 3 = 75%	4 = 100%		4 = 100%			
2	<b>IDLE LCD LIGHT</b> If any key on the Remote Control EVO-RC has not been pressed for time set by parameter "IDLE LCD TIMER", the backlight will dim to the programmed option	0 = 0% 1 = 25%	2 = 50% 3 = 75%	4 = 100%		1 = 25%			
3	<b>IDLE LCD TIMER</b> If any key on the Remote Control EVO-RC has not been pressed for time set by this parameter, the backlight will dim to the programmed option selected through parameter "IDLE LCD LIGHT"	1 to 59 min.				1 min.			

## 4.9.2 Description of Parameters Under Group 6 – RC SETTING

### 4.9.2.1 ACTIVE LCD LIGHT *(Table 4.8, Parameter Setup Screen No.1)*

This parameter determines the level of brightness / dimming of the LCD backlight of Remote Control EVO-RC during the "Active" operation of the LCD display (*when not in "Idle Mode" - see Section 4.9.2.2*)

The default is option "4=100%" (*Fully bright*).

#### 4.9.2.1.1 Programming Steps for Parameter "ACTIVE LCD LIGHT"

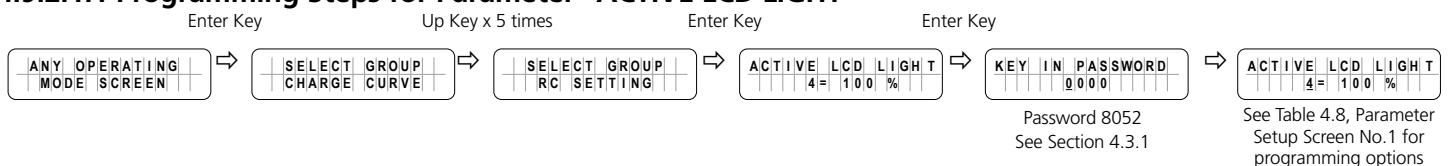

### 4.9.2.2 IDLE LCD LIGHT *(Table 4.8, Parameter Setup Screen No.2)*

This parameter determines the level of brightness / dimming of the LCD backlight of Remote Control EVO-RC when the LCD display is in "IDLE MODE". "IDLE MODE" of the LCD display is activated if any key on the EVO-RC Remote Control has not been depressed for a time period set by parameter "IDLE LCD TIMER" (*see details at Section 4.9.2.3*).

The default setting is option "1=25%".

**NOTE:** *If the LCD display is in dimmed condition set by parameter "IDLE LCD LIGHT" and any key on the EVO-RC Remote Control is depressed, the LCD backlight level will change to the level set by parameter ACTIVE LCD LIGHT (Section 4.9.2.1).*

## SECTION 4 | Parameter Setup

### 4.9.2.2.1 Programming Steps for Parameter "IDLE LCD LIGHT"

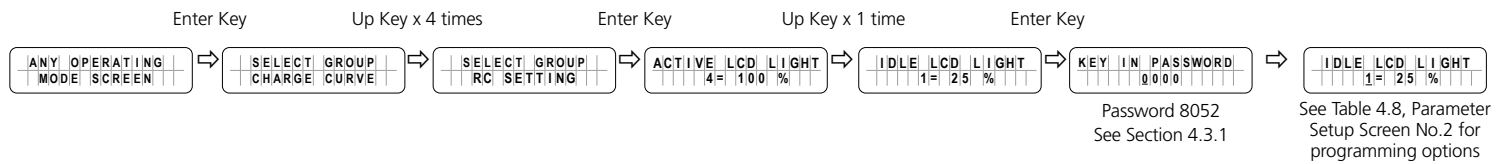

### 4.9.2.3 IDLE LCD TIMER (Table 4.8, Parameter Setup Screen No.3)

During the active operation mode of the LCD display, its level of brightness is controlled by parameter "ACTIVE LCD LIGHT" (Section 4.9.2.1). If any key on the EVO-RC Remote Control has not been depressed for time set by this parameter i.e. "IDLE LCD TIMER", the backlight of the LCD screen will be dimmed to the level set by parameter "IDLE LCD LIGHT" (Section 4.9.2.2).

### 4.9.2.3.1 Programming Steps for Parameter "IDLE LCD TIMER"

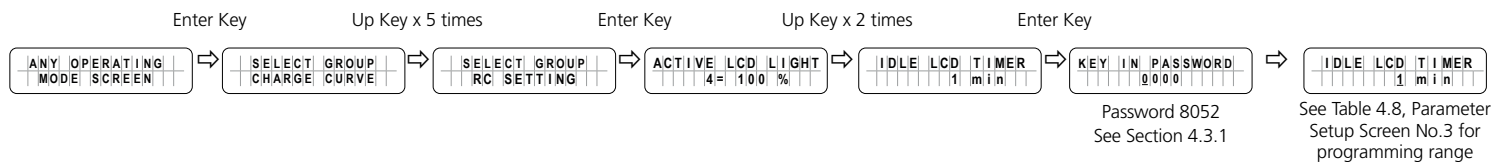

## 4.10 GROUP 7 PARAMETER SETUP: TIME SETTING (Section 4.1, Fig 4.2, Group 7)

Please refer to Parameter "TIME SETTING" under Group 7 at Fig 4.2. Set up details are given below. The Date and Time Format is Year/Month/Day Hour:Minute (24 hour clock):

### 4.10.1 Programming Steps for Parameter "TIME SETTING"

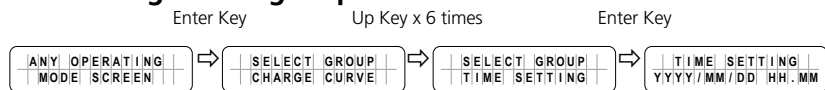

#### INFO

- Time can be programmed from Year 2000 to 2099 only.
- Month can be programmed from 01 to 12 only.
- Day can be programmed from 01 to 31 only.
- Hour can be programmed from 00 to 24 only.
- Minute can be programmed from 00 to 60 only.
- If the numbers Entered for Month, Day, Hour and Minute are not within the above ranges, message "OUT OF RANGE!" will be displayed and the display screen will go back to the previously set time. Setting procedure will have to be re-started.

## 4.11 GROUP 8 PARAMETER SETUP: STOP SD CARD (Section 4.1, Fig 4.2, Group 8)

Please refer to Parameter "STOP SD CARD" under Group 8 at Fig 4.2. Please note that this set up is displayed / accessible only when SD Card is inserted in the SD Card Slot (9, Fig 1.1a). Set up details are given below:



## SECTION 4 | Parameter Setup

Once SD Card is being used, it should be removed/ejected only after the operation of the Card has been stopped as shown below and message "Please remove SD Card" appears. If the SD card is not removed within 30 sec, it will reset. After the card is removed, it reverts to the original operating screen.

### 4.11.1 Programming Steps for Parameter "STOP SD CARD"

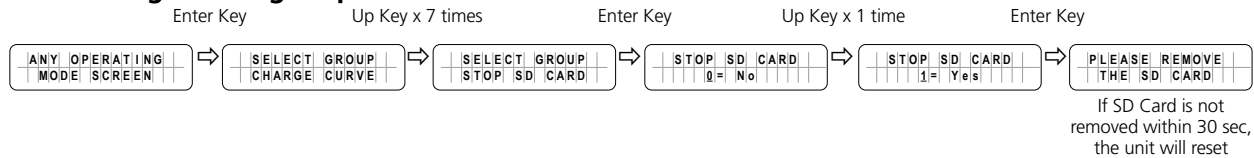

## SECTION 5 | SD Card

### 5.1 SD CARD GENERAL INFORMATION

SD Card slot has been provided for using an SD card for (i) data logging and (ii) saving programmed parameters. SD card supports FAT16/FAT32 format up to 32GB in size.

When the SD card is inserted, the LCD screen will display the following.

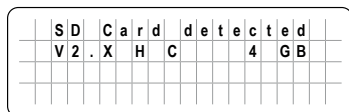

SD card is detected and shows the Version and capacity. "xx" is the capacity.

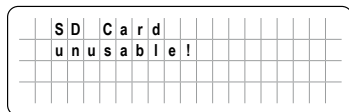

Not supported card.



#### CAUTION!

Do not remove SD Card when data logging has been enabled (*may corrupt files*). Follow "STOP SD CARD" procedure ([Section 4.11](#)) before removing the SD Card.



#### ATTENTION!

Ne pas retirer la carte SD lorsque « data loggin » a été activée (peut corrompre les fichiers). Suivez la procédure "STOP SD CARD" ([article 4.11](#)) avant de retirer la carte SD .

# SECTION 5 | SD Card

## 5.2 DATA LOGGING

### 5.2.1 General Information

Data Logging uses external SD Card (See Section 5.1 above) to record the values of various Operating Parameters / Events/Errors with Date and Time stamp controlled by an internal Real Time Clock (RTC). **It is, therefore, necessary that before starting data logging, the current Date and Time should be set (if not set already) by using parameter "TIME SETTING" (Section 4.10)**

Operating Parameters/Events/Errors are recorded under "Data Logging Fields" (See Section 5.2.2 for information on Data Logging Fields for various EVO™ Models).

Operating Parameters/Events/Errors are recorded as follows:

- **Operating Parameters:** The recorded values of the various Operating Parameters are their "Average Values" computed from "Instantaneous Values" scanned over a programmable "time interval" set by programming parameter "DATALOG TIME" (Section 4.8.2.10) with options (i) 0=Disable, (ii) 1=1 sec (Default), (iii) 2=10sec, (iv) 3=30sec, (v) 4=60sec, (vi) 5=5min, (vii) 6=10min.
- **Events / Errors:** These are recorded as soon as they are sensed.

With default setting of parameter "DATALOG TIME" (Section 4.8.2.10) set at option "1=1sec", data logging will commence as soon as the SD Card is inserted in the SD Card Slot in the EVO-RC Remote Control (Section 5.2.3). In case parameter "DATALOG TIME" (Section 4.8.2.10) has been set at option "0=Disable", data logging will NOT commence automatically when the SD Card is inserted in the SD Card Slot in the EVO-RC Remote Control.

### 5.2.2 DATA LOGGING Fields

Various Operating Parameters "Error Codes" and "Events" are recorded under DATA LOGGING fields shown in Fig 5.1.

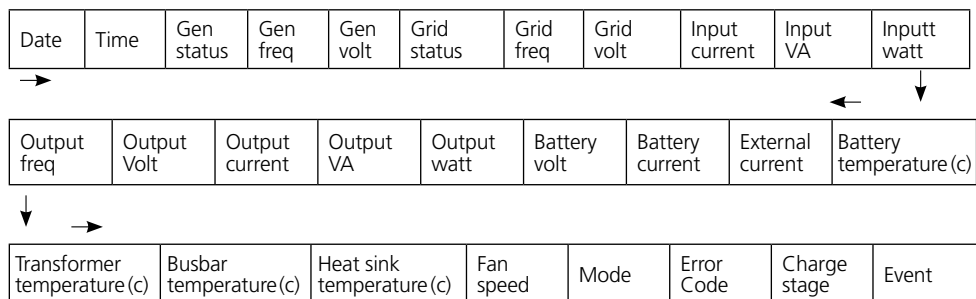

**Fig 5.1 Data Logging Fields for (i) EVO-2212 / 3012 / 2224 / 4024 & (ii) EVO-2212E / 3012E / 2224E / 4024E**

The Data Logging Fields in Fig 5.1 above show the average value over one of the 6 time interval options shown below under programming parameter "DATALOG TIME" (See Section 4.8.2.10). Default time interval is 1 sec (Option "1=1 sec). Parameter "DATALOG TIME" is also used to disable data logging (Option 0=Disable). Interval / disabling options are shown below:

- 0=Disable ; 1=1 sec (Default) ; 2=10 sec ; 3=30 sec ; 4=60 sec ; 5=5 min ; 6=10 min

**NOTE:** Data Logging Fields "Error Code" and "Event" shown in Fig 5.1 above record "Error Code"/"Event" as soon as they occur

## SECTION 5 | SD Card

### 5.2.3 Operating Screens when SD Card is Inserted for Data Logging

Data logging will be carried out automatically as soon as the SD Card is inserted in the SD Card Slot of EVO-RC-PLUS. [Provided parameter "DATALOG TIME" (Section 4.8.2.10) has NOT been set to "0 = Disable"].

Operating screens are shown below:

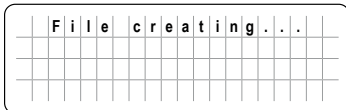

Data log function has been initiated and new file is being created. Do not remove the SD card when file creating is displayed.

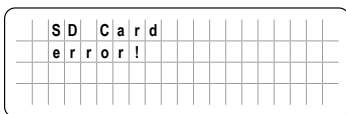

Read error, the data log function/update/upload will stop.

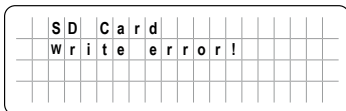

Write error. The Data logging function will stop.

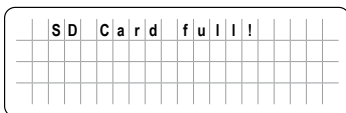

1. Card full. Data logging function has stopped.
2. There is not enough space to create Data Log File Folder or to save file with saved programmed parameters.

**NOTE:** Once there is enough space to create a Data Log File Folder and subsequently, it runs out of capacity due to recording newer data, it will start to overwrite on older files.

### 5.2.4 Disabling Data Logging

In the factory default condition, data logging has been enabled at 1 sec recording interval [Parameter "DATALOG TIME" (Section 4.8.2.10) has been set to option "1=1 sec"]. Hence, data logging will commence as soon as SD Card is inserted.













To disable data logging, parameter "DATALOG TIME" (Section 4.8.2.10) has to be set at option "0=Disable".

## 5.3 DATA LOG FILES AND VIEWING DATA LOG FILES USING MICROSOFT EXCEL

**5.3.1** Data Log Files are written as De-limited Text Files (.txt) in the DATALOG Folder on the SD Card's Root Directory. Table 5.1 is an image of the DATALOG Folder showing example of the De-limited Data Log Files. The File Name Format is month/day/hour/minute.txt (MMDDhhmm.txt). Each file has 512 rows of records. (Each row has multiple data fields as described at Section 5.2.2). **Each file size is 128kb.**

## SECTION 5 | SD Card

**TABLE 5.1 Example of Data Log Folder in SD Card's Root Directory**

Name	Date modified	Type	Size
 07160007.txt	2018-07-25 12:13 PM	Text Document	128 KB
 07160016.txt	2018-07-25 12:13 PM	Text Document	128 KB
 07160024.txt	2018-07-25 12:13 PM	Text Document	128 KB
 07160033.txt	2018-07-25 12:13 PM	Text Document	128 KB
 07160041.txt	2018-07-25 12:13 PM	Text Document	128 KB
 07160050.txt	2018-07-25 12:13 PM	Text Document	128 KB
 07160058.txt	2018-07-25 12:13 PM	Text Document	128 KB
 07160107.txt	2018-07-25 12:13 PM	Text Document	128 KB
 07160115.txt	2018-07-25 12:13 PM	Text Document	128 KB
 07160124.txt	2018-07-25 12:13 PM	Text Document	128 KB
 07160132.txt	2018-07-25 12:13 PM	Text Document	128 KB
 07160141.txt	2018-07-25 12:13 PM	Text Document	128 KB

**5.3.2** *Table 5.2* shows an example of the contents of one of the ".txt" files opened with a general purpose Text Reader, e.g. Microsoft Notepad. The 1st Row shows the Model No. (*EVO-4024 in this example*).The 2nd Row shows Data Logging Fields separated by semicolon i.e. ";" (*see details of all the Data Logging Fields for various EVO™ models at Section 5.2.2*). The 3rd Row onwards shows the values/status of the Data Logging Fields at time interval equal to the programming value of programmed parameter DATALOG TIME (*See Section 4.8.2.10*).

**NOTE: Data Logging Fields "Error Code" and "Event" will be logged as soon as they occur.**

## SECTION 5 | SD Card

**TABLE 5.2 Example of Data Log Text File "0716007.txt" for Model No. EVO-4024 as seen through Text Editor "Notepad"**

TABLE 5.2 Example of Data Log Text File "0716007.txt" for Model No. EVO-4024 as seen through Text Editor "Notepad"
 <b>07160007.txt - Notepad</b> <b>File Edit Format View Help</b>
<b>EVO-4024</b>
Date; Time; Gen status; Gen freq; Gen volt; Grid status; Grid freq; Grid volt; Input current; Input VA; Input watt; Output freq; Output volt; Output current; Output VA; Output watt; Battery volt; Battery current; External current; Battery temperature (C); Transformer temperature (C); Bus bar temperature (C); Heat sink temperature (C); Fan speed; Mode; Error Code; Charge Stage; Event. <i>(See NOTE 2)</i>
2018/07/16; 00:07:51; 33343; 000.00; 000.65; 00000; 059.94; 123.44; 009.18; 01133; 01103; 059.94; 123.55; 008.23; 01015; 01015; 27.734; 0002.7; 0000.0; 0022.8; 0051.8; 0039.2; 0032.0; 0; 2; 0000; 4; <i>(See NOTES 2 and 3)</i>
2018/07/16; 00:07:52; 33343; 000.00; 000.65; 00000; 059.94; 123.43; 009.23; 01140; 01110; 059.94; 123.52; 008.28; 01022; 01025; 27.694; 0002.7; 0000.0; 0022.8; 0051.8; 0039.2; 0032.0; 0; 2; 0000; 4; <i>(See NOTES 2 and 3)</i>
2018/07/16; 00:07:53; 33343; 000.00; 000.65; 00000; 059.94; 123.45; 009.28; 01146; 01116; 059.94; 123.55; 000.30; 01024; 01025; 27.694; 0002.7; 0000.0; 0022.8; 0051.8; 0039.2; 0032.0; 0; 2; 0000; 4; <i>(See NOTES 2 and 3)</i>
<b>NOTES:</b>
<ol style="list-style-type: none"> <li>1. Example of data displayed in for 120VAC Model No. EVO 4024. Data displayed for EVO-2212E/3012E/2224E/4024E will be similar but voltages will be 230VAAC and frequency 50 Hz.</li> <li>2. There are 28 Data Logging Fields for Model Nos. EVO-2212/2212E/3012/3012E/2224/2224E/4024/4024E (Date; Gen status; Gen freq; etc.). In the actual ".txt file", these fields will be displayed across one single horizontal line</li> <li>3. The values of the 28 Data Logging Fields (2018/07/16; 00:07:51; 33343; 000.00; 000.65; etc.) will also be displayed across one single horizontal line</li> <li>4. The 3 lines of values for the 28 Data Logging Fields (2018/07/16; 00:07:51; 33343; 000.00; 000.65; etc.) shown above are the first 3 lines from 512 lines contained in a ".txt" file. The value / status of each of the 512 line is recorded at the default "DATALOG TIME" <i>(Section 4.8.2.10)</i> of 1 sec interval.</li> </ol>

### 5.3.2.1 Follow procedure given below to open Data Log Files in Microsoft Excel *(Version used is 2016)*:

- Start Microsoft Excel.
- Click File Menu Tab on the top left hand corner.
- Click "Open" from the Drop Down Menu.
- Browse to the Directory where the Data Log Files downloaded from the SD Card are located.
- Click on "File Types" List Box at the bottom right corner *(the List Box shows "All Excel Files" as default)* and select Text Files from the Drop Down Menu.
- All Text Files (.txt) will be displayed. The screen will look like Fig 5.2.

## SECTION 5 | SD Card

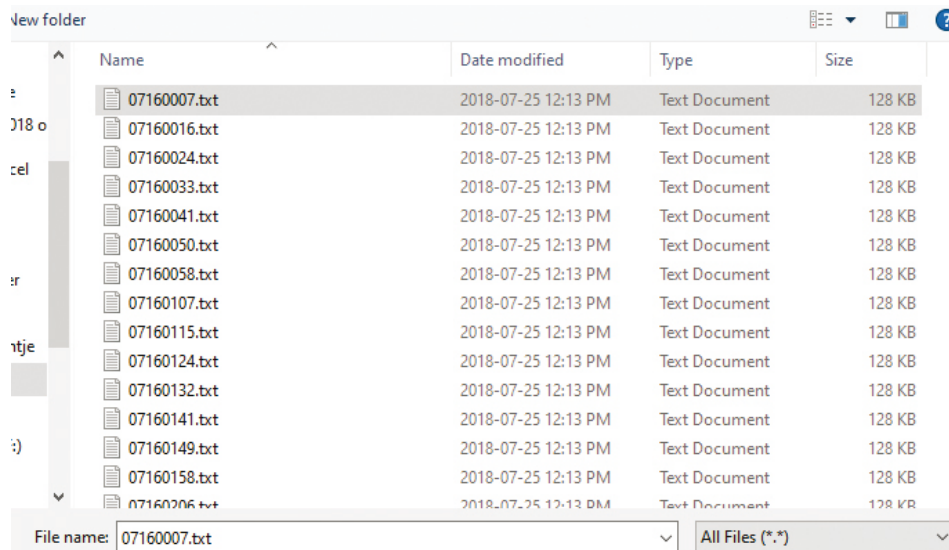

**Fig 5.2 Screen Showing ".txt" Files downloaded from SD Card into Computer Directory**

- Click "Open" Button (*Bottom right corner of Fig 5.4*).
- "Text Import Wizard – Step 1 of 3" will be shown (*Fig 5.3*). Choose "Delimited" File Type".

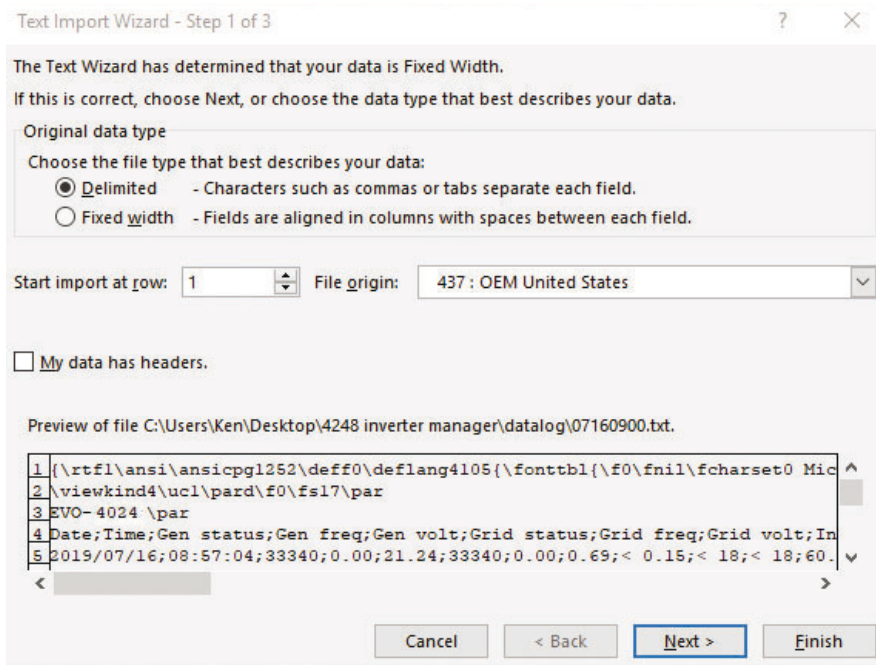

**Fig 5.3 Screen showing Step 1 of 3 of "Text Import Wizard" in Excel**

## SECTION 5 | SD Card

- Text Import Wizard – Step 2 will appear (See Fig 5.4). Choose "Semicolon" and click 'Finish' button.

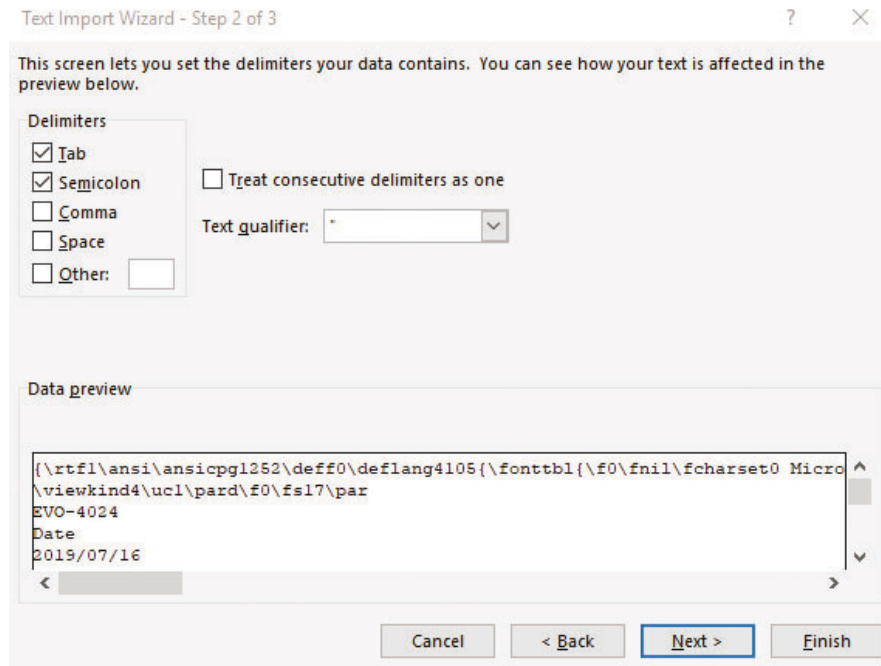

Fig 5.4 Screen showing Step 2 of 3 of "Text Import Wizard" in Excel

- Data as in Fig 5.5 will be displayed on your Worksheet, with the Log Data stored in Columns and Rows.

**NOTE:** Example of data shown in Fig 5.5 is for 120VAC Model No. EVO-4024. Data for 230VAC versions EVO-2212E/3012E/2224E/4024E will be similar but voltages will be 230VAC and frequen

1	A	D	U	L	T	U	T	I	V	K	L	M	R	U	F	M	R	O	T	V	X	A	T	C	PH	PO	
2	EVO-4024																										
3	2018-07-18	0:07:51	33343	0	0.65	0	59.94	123.44	8.28	1133	1100	59.94	123.55	8.23	1018	1018	27.734	2.7	0	79.2	125.4	102.7	89.7	0	2	0	4
4	2018-07-18	0:07:52	33343	0	0.65	0	59.94	123.43	8.23	1140	1110	59.94	123.52	8.28	1022	1028	27.684	2.7	0	79.2	125.4	102.7	89.7	0	2	0	4
5	2018-07-18	0:07:53	33343	0	0.65	0	59.94	123.45	8.26	1146	1116	59.94	123.55	8.3	1024	1025	27.684	2.7	0	79.2	125.4	102.7	89.9	0	2	0	4
6	2018-07-18	0:07:54	33343	0	0.65	0	59.94	123.46	8.26	1143	1113	59.94	123.58	8.27	1022	1020	27.734	2.8	0	79	125.4	102.7	89.9	0	2	0	4
7	2018-07-18	0:07:55	33343	0	0.65	0	60.06	123.46	8.14	1129	1098	60.06	123.56	8.17	1010	1008	27.734	2.7	0	79	125.4	102.7	89.9	0	2	0	4
8	2018-07-18	0:07:56	33343	0	0.66	0	59.94	123.48	8.12	1127	1096	59.94	123.58	8.15	1007	1006	27.734	2.8	0	79.2	125.4	102.5	89.7	0	2	0	4
9	2018-07-18	0:07:57	33343	0	0.65	0	60.06	123.46	8.05	1114	1083	60.06	123.56	8.06	994	995	27.734	2.9	0	79	125.4	102.7	89.9	0	2	0	4
10	2018-07-18	0:07:58	33343	0	0.64	0	59.94	123.5	8.04	1116	1085	59.94	123.58	8.05	994	992	27.734	2.6	0	79.2	125.4	102.7	89.9	0	2	0	4
11	2018-07-18	0:07:59	33343	0	0.65	0	59.94	123.5	8.97	1109	1077	59.94	123.58	8.02	992	992	27.684	2.6	0	79	125.4	102.7	89.9	0	2	0	4
12	2018-07-18	0:08:00	33343	0	0.65	0	59.94	123.44	8.19	1134	1105	59.94	123.53	8.25	1014	1016	27.684	2.7	0	79.2	125.4	102.7	89.9	0	2	0	4
13	2018-07-18	0:08:01	33343	0	0.65	0	60.06	123.46	8.2	1136	1107	60.06	123.54	8.25	1014	1019	27.734	2.7	0	79	125.4	102.7	89.9	0	2	0	4
14	2018-07-18	0:08:02	33339	0	0.65	0	60.06	123.48	8.14	1129	1099	60.06	123.57	8.19	1012	1019	27.734	2.8	0	79	125.4	102.7	89.9	0	2	0	4
15	2018-07-18	0:08:03	33343	0	0.65	0	60.06	123.48	8.3	1148	1119	60.06	123.56	8.33	1028	1030	27.684	2.9	0	79	125.4	102.7	89.9	0	2	0	4
16	2018-07-18	0:08:04	33343	0	0.64	0	59.94	123.44	8.39	1160	1131	59.94	123.49	8.42	1041	1043	27.734	2.7	0	79	125.4	102.7	89.9	0	2	0	4
17	2018-07-18	0:08:05	33343	0	0.64	0	59.94	123.46	8.23	1139	1109	59.94	123.53	8.27	1021	1021	27.734	2.8	0	79.2	125.4	102.8	89.7	0	2	0	4
18	2018-07-18	0:08:06	33343	0	0.65	0	59.94	123.46	8.25	1143	1113	59.94	123.54	8.28	1022	1023	27.734	2.5	0	79.2	125.4	102.7	89.9	0	2	0	4
19	2018-07-18	0:08:07	33339	0	0.64	0	59.94	123.46	8.23	1140	1110	59.94	123.57	8.27	1021	1021	27.734	2.8	0	79.2	125.7	102.7	89.9	0	2	0	4
20	2018-07-18	0:08:08	33343	0	0.65	0	60.06	123.37	8.22	1137	1106	60.06	123.45	8.25	1018	1018	27.684	2.9	0	79.2	125.4	102.8	89.9	0	2	0	4

Fig 5.5 Screen showing Data Log Work Sheet in Excel





## SECTION 6 | Monitoring of Operation Using LED and Buzzer

<b>Table 6.1 LED &amp; BUZZER INDICATIONS FOR OPERATION MONITORING</b>			
<b>Status</b>	<b>Green LED "Status"</b>	<b>Red LED "Fault"</b>	<b>Buzzer (See Note 1)</b>
Seen during Power-On Sequence Refer to Section 3.2.1	Blink 3 times & then turn off	OFF	OFF
Seen during Power-Off Sequence Refer to Section 3.2.2	ON	ON	OFF
Normal charging	Blink once in 1 sec interval	OFF	OFF
Equalization charging	Blink twice in 1 sec interval	OFF	OFF
Inverting	ON	OFF	Beep once in 3 sec interval
Low battery alarm	ON	Blink once in 1 sec interval	Beep once in 1 sec interval
Power saving	Blink once in 3 sec interval	OFF	OFF
Standby	Blink once in 5 sec interval	OFF	OFF
Fault	OFF	ON	ON

**NOTE:**

1. Buzzer is available only in EVO™ Inverter/Charger. There is no buzzer in Remote Control EVO-RC.

# SECTION 7 | Fault Messages and Troubleshooting Guide



**CAUTION!**

The cause of the fault should be removed before the unit is restarted.



**ATTENTION!**

La cause de la panne doit être retiré avant un redémarrage de l'appareil.

**TABLE 7.1 FAULT MESSAGES AND TROUBLESHOOTING GUIDE**



**NOTES:** 1. Please see Table 6.1 for LED indications in EVO-RC and buzzer indications in EVO™ Inverter/Charger  
 2. Buzzer is available only in EVO™ Inverter/Charger. There is no buzzer in Remote Control EVO-RC

Srl. No	Fault Message	Symptoms and Troubleshooting
1		<ul style="list-style-type: none"> <li>EVO™ is in <b>"FAULT MODE"</b> because the battery voltage has dropped to the set lower threshold of "BATT LOW VOLTAGE" (<a href="#">Section 4.4.2.9</a>)</li> <li>When the battery voltage drops to the threshold of parameter "BATT LOW VOLTAGE" (<a href="#">Section 4.4.2.9</a>), activation of this fault protection is initiated. The Red LED marked "Fault" will flash once per second and the buzzer in the EVO™ will beep once per second. <i>The Inverter Section will continue to operate normally, and the Green LED marked "Status" will continue to be ON steady</i> (<b>NOTE: Fault message "Battery low voltage!" will not be displayed during this time</b>)</li> <li>If the battery voltage stays at or below the threshold of "BATT LOW VOLTAGE" (<a href="#">Section 4.4.2.9</a>) for duration equal to parameter "LV DETECT TIME" (<a href="#">See Section 4.4.2.10</a>), only the Inverter Section will be switched OFF and fault message "Battery low voltage!" will be displayed. The Red LED marked "Fault" will now change to steady ON, the Green LED marked "Status" will switch OFF and the buzzer in EVO™ will now beep steady. <i>The unit will get locked in this condition and will be required to be switched off as follows:</i> <ul style="list-style-type: none"> <li>The unit will automatically switch off after expiry of time set by parameter "LV CUT OFF TIME" (<a href="#">See Section 4.4.2.11</a>). [<i>LCD Display / LED / Buzzer will be OFF</i>], or</li> <li>In case the time set by parameter "LV CUT OFF TIME" (<a href="#">See Section 4.4.2.11</a>) has not expired, switch off the unit manually (<a href="#">See Section 3.2.2</a>)</li> </ul> </li> <li>While in "Battery low voltage!" fault condition, if qualified AC input is made available before expiry of time set by parameter "LV CUT OFF TIME" (<a href="#">Section 4.4.2.11</a>), the unit will automatically reset to "Charging Mode" <i>provided the battery voltage is &gt;9V for EVO-2212/3012/2212E/3012E or &gt;18V for EVO-2224/4024/2224E/4024E.</i> <ul style="list-style-type: none"> <li>In case it is desired that the unit should not switch off due to "Battery low fault!" condition after expiry of time set by parameter "LV CUT OFF TIME" (<a href="#">Section 4.4.2.11</a>) but should automatically reset to "Charging Mode" on availability of qualified AC input voltage with battery voltage &gt; 9V for EVO-2212/3012/2212E/3012E or &gt;18V for EVO-2224/4024/2224E/4024E, <i>time value of parameter "LV CUT OFF TIME" should be changed to 0 sec (Refer to Section 4.4.2.9.2)</i></li> </ul> </li> <li>If the batteries are charged by external charger connected directly to the batteries or through the External Charger Input (<a href="#">3, 4 in Fig 2.1 in the attached EVO™ Owner's Manual</a>) <b>and</b> the battery voltage recovers to the set threshold of parameter "RESET VOLTAGE" (<a href="#">Section 4.4.2.7</a>) before the expiry of time set by parameter "LV CUT OFF TIME" (<a href="#">Section 4.4.2.11</a>) while in "Battery low voltage!" fault condition, the Inverter Section will restart and "Battery low voltage!" fault condition will be cleared.</li> </ul>





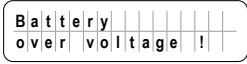
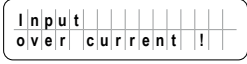

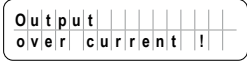
# SECTION 7 | Fault Messages and Troubleshooting Guide

Srl. No	Fault Message	Symptoms and Troubleshooting
2		<ul style="list-style-type: none"> <li>EVO™ is in <b>FAULT MODE</b> because the battery voltage has <i>dropped momentarily for 1 ms</i> to (i) 9V or below for EVO-2212/3012/2212E/3012E or, (ii) 18V or below for EVO-2224/4024/2224E/4024E.</li> <li>The Inverter Section will be switched OFF and message “Battery ultra low voltage!” will be displayed. Red LED marked “Fault” will be steady ON, Green LED marked “Status” will be switched OFF and the buzzer in EVO™ will beep steady. <i>The unit will get locked in this condition and will be required to be switched off as follows:</i> <ul style="list-style-type: none"> <li>The unit will automatically switch off after expiry of time set by parameter “LV CUT OFF TIME” (Section 4.4.2.11) [LCD display / LED / Buzzer will be OFF], or</li> <li>In case the time set by parameter “LV CUT OFF TIME” (Section 4.4.2.11) has not expired, switch off the unit manually (See Section 3.2.2)</li> </ul> </li> <li>While in “Battery ultra low voltage!” fault condition, if qualified AC input is made available before expiry of time set by programming parameter “LV CUT OFF TIME” (Section 4.4.2.11), the unit will automatically reset to “Charging Mode” <i>provided the battery voltage is &gt;9V for EVO-2212/3012/2212E/3012E or &gt;18V for EVO-2224/4024/2224E/4024E.</i> <ul style="list-style-type: none"> <li>In case it is desired that the unit should <b>NOT</b> switch off due to “Battery ultra low voltage!” fault condition after expiry of time set by parameter “LV CUT OFF TIME” (Section 4.4.2.11) but should automatically reset to “Charging Mode” on availability of qualified AC input voltage with battery voltage &gt;9V for EVO-2212/3012/2212E/3012E or &gt;18V for EVO-2224/4024/2224E/4024E, value of time set by parameter “LV CUT OFF TIME” should be <b>changed to 0 sec</b> (Refer to Section 4.4.2.9.2)</li> </ul> </li> <li>If the batteries are charged by external charger connected directly to the batteries or through the External Charger Input (3, 4 in Fig 2.1 in the EVO™ Owner’s Manual) <b>and</b> the battery voltage recovers to the set threshold of parameter “RESET VOLTAGE” (Section 4.4.2.7) before the expiry of time set by parameter “LV CUT OFF TIME” (Section 4.4.2.11) while in “Battery ultra low voltage!” fault condition, the Inverter Section will restart and “Battery ultra low voltage!” fault condition will be cleared.</li> </ul> <p><b>NOTE:</b></p> <p>Momentary low voltage threshold of 9V or lower for 1 ms for EVO-2212/3012/2212E/3012E or 18V or lower for 1 ms for EVO-2224/4024/2224E/4024E that triggers <b>“Battery ultra low voltage!”</b> fault is likely to be reached under the following operating conditions:</p> <ol style="list-style-type: none"> <li>The threshold of parameter “BATT LOW VOLTAGE” (Section 4.4.2.9) has been set at very low Depth of Discharge – slightly above the lower programming limit of 9V for EVO-2212/3012 or slightly above 18V for EVO-2224/4024/2224E/4024E. When the battery voltage approaches this low level of discharge, <i>its internal resistance will be considerably higher</i> as compared its internal resistance at higher State of Charge</li> <li>AC load(s) being powered are of a type that draw very high starting surge current spikes. Examples of such types of loads are (i) Switched Mode Power Supply (SMPS) based devices like Battery Chargers / AC to DC Adapters/ AC to DC Drivers for LEDs (iii) Compact Fluorescent Lamps (CFL), (iv) Quartz Lamps, (v) Ceramic Heaters, (vi) Compressors, (vii) Motors and (viii) Laser Printers etc.</li> <li>When the above type of AC loads [See (b) above] are switched on in Inverting Mode, the high starting surge current spikes will produce considerably higher voltage drop across higher internal resistance of the battery because of operation at deeply discharged level approaching threshold set by parameter “BATT LOW VOLTAGE” threshold (Section 4.4.2.9). When this momentary drop is equal to 9V/18V or lower, the unit enters <b>“Battery ultra low voltage!”</b> fault condition</li> </ol>

# SECTION 7 | Fault Messages and Troubleshooting Guide

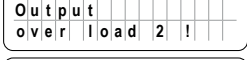
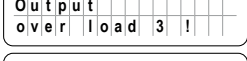
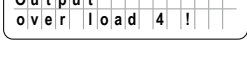
Srl. No	Fault Message	Symptoms and Troubleshooting
3		<p>EVO™ Inverter/Charger is in <b>FAULT MODE</b> because the battery voltage has risen to the set upper threshold of "BATT OVER VOLTAGE" (<a href="#">Section 4.4.2.6</a>)</p> <p><b>(a) AC input is not available and EVO™ Inverter/Charger is operating in Inverting Mode:</b></p> <ul style="list-style-type: none"> <li>There will be no AC output because the Inverter Section will be switched OFF. The Green LED marked "Status" will be switched OFF and the Red LED marked "Fault" will be steady ON. The buzzer in EVO™ Inverter/Charger will beep steady</li> <li>The fault will be cleared automatically when the battery voltage drops to 0.5V below the set upper threshold of "BATT OVER VOLT" (<a href="#">Section 4.4.2.6</a>)</li> </ul> <p><b>(b) AC input is available and EVO™ Inverter/Charger is operating in Charging Mode:</b></p> <ul style="list-style-type: none"> <li>There will be no AC output or charging because the Transfer Relay will be de-energized and PWM drive to the Inverter Section will be switched OFF.</li> <li>The fault will be cleared automatically when the battery voltage drops to 0.5V below to the set upper threshold of "BATT OVER VOLT" (<a href="#">Section 4.4.2.6</a>). The EVO™ Inverter/Charger will restart in Inverting Mode, synchronize with the AC input and then, the Transfer Relay will be energized to transfer to AC input at zero crossing. The unit will, thus, resume operation in "Charging Mode"</li> </ul>
4		<p> <b>INFO</b></p> <p>This FAULT MODE will be activated only when parameter "INPUT OC PROTECT" has been set to option "1=shutdown" (<a href="#">See Section 4.5.2.10 for additional details</a>).</p> <p>EVO™ Inverter/Charger is in <b>FAULT MODE</b> because the input current being drawn from the AC input source (Input current = Charging Current + Pass Through Current to the load) is 1A more than the set threshold of " GRID MAX CURRENT" (<a href="#">Section 4.5.2.2</a>) / "GEN MAX CURRENT" (<a href="#">Section 4.5.2.3</a>) for 5 seconds (current is sampled every 33.3 μs).</p> <ul style="list-style-type: none"> <li>There will be no AC output because the Transfer Relay will be de-energized, charging will be stopped and PWM drive to the Inverter Section will be switched OFF. The Green LED marked "Status" will be switched OFF and the Red LED marked "Fault" will be steady ON. The buzzer in EVO™ Inverter/Charger will beep steady</li> <li><b>EVO™ Inverter/Charger will be latched in OFF condition and will require manual reset by powering OFF, waiting for 1 minute and then powering ON again</b></li> <li>The set threshold of " GRID MAX CURRENT" (<a href="#">Section 4.5.2.2</a>) / "GEN MAX CURRENT" (<a href="#">Section 4.5.2.3</a>) should match the breaker capacity of the AC input source / AC input Branch Circuit. If AC input current capacity cannot be increased, reduce the AC load / "BULK CURRENT" (<a href="#">Section 4.4.2.1</a>) accordingly.</li> </ul>
5		<p>EVO™ Inverter/Charger is in <b>FAULT MODE</b> because the instantaneous output current being drawn by the AC load in <b>Inverting Mode</b> is 330% of the rated value of the EVO™ Inverter/Charger for 2 samples (current is sampled every 33.3 μs).</p> <ul style="list-style-type: none"> <li>There will be no AC output because the Inverter Section will be switched OFF. The Green LED marked "Status" will be switched OFF and the Red LED marked "Fault" will be steady ON. The buzzer in EVO™ Inverter/Charger will beep steady</li> <li><b>EVO™ Inverter/Charger will be latched in OFF condition and will require manual reset by powering OFF, waiting for 1 minute and then powering ON again</b></li> <li>Ensure that the maximum instantaneous surge current of the load is not more than 300% of the rated current of the EVO™ Inverter/Charger for 1 millisecond</li> </ul>

# SECTION 7 | Fault Messages and Troubleshooting Guide

Srl. No	Fault Message	Symptoms and Troubleshooting
6	    	<p>EVO™ Inverter/Charger is in <b>FAULT MODE</b> because of overload conditions in <b>Inverting Mode</b>:</p> <ul style="list-style-type: none"> <li>• There will be no AC output because the Inverter Section will be switched OFF. The Green LED marked "Status" will be switched OFF and the Red LED marked "Fault" will be steady ON. The buzzer in EVO™ Inverter/Charger will beep steady</li> <li>• <b>EVO™ Inverter/Charger will be latched in OFF condition and will require manual reset by powering OFF, waiting for 1 minute and then powering ON again</b></li> <li>• Ensure that overloading is limited to the specified limit</li> </ul> <p>Output voltage is less than 96Vrms for 300 cycles (<i>5 seconds at 60Hz</i>)</p> <p>Output power is over the Power Boost Rating (110%) for 30 min</p> <p>Output power is over the Power Boost Rating (120%) for 5 minutes</p> <p>Output power is over the Power Boost Rating (140%) for 30 seconds</p> <p>Output power is over the Power Boost Rating (150%) for 5 seconds</p>
7		<p>EVO™ Inverter/Charger is in <b>FAULT MODE</b> because there is a short circuit on the output side in Inverter Mode. Short circuit protection is activated when (i) the output current is over 18.33 Arms for EVO-2212/2224, 25 Arms for EVO-3012, 33.33 Arms for EVO-4024, 9.56 Arms for EVO-2212E/2224E, 17.39 Arms for EVO-3012E and 33.33 Arms for EVO-4024E) and (ii) output voltage is less than 15 Vrms for 6 cycles (<i>0.1 second for 60 Hz</i>) for 120VAC Models and, less than 15 Vrms for 6 cycles (<i>0.12 second for 50 Hz</i>) for 230VAC Models. (NOTE: Current is sampled every 33.3 μs)</p> <ul style="list-style-type: none"> <li>• There is no AC output because the Inverter Section has been switched OFF. The Green LED marked "Status" will be switched OFF and the Red LED marked "Fault" will be steady ON. The buzzer in EVO™ Inverter/Charger will beep steady</li> <li>• <b>EVO™ Inverter/Charger will be latched in OFF condition and will require manual reset by powering OFF, waiting for 1 minute and then powering ON again</b></li> </ul> <p><b>NOTE:</b> If there is short circuit condition in Charging Mode i.e. when AC input is available, short circuit condition on the output side will trip the AC input breaker. The load will be transferred to the Inverter Section and the Inverter Section will then see short circuit condition and will shut down as described above</p>
8		<p>EVO™ Inverter/Charger is in <b>FAULT MODE</b> because AC input from Grid / Generator has been connected to the AC Output terminals by mistake. 10VAC or above seen at the AC Output Terminals at the time of boot up of EVO™ Inverter/Charger will activate this protection</p> <ul style="list-style-type: none"> <li>• The Green LED marked "Status" will be switched OFF and the Red LED marked "Fault" will be steady ON. The buzzer in EVO™ Inverter/Charger will beep steady</li> <li>• <b>EVO™ Inverter/Charger will be latched in OFF condition and will require manual reset by powering OFF, waiting for 1 minute and then powering ON again</b></li> </ul> <p>Check the connection. If there is 10V over at the output terminal, remove the connection.</p>
9		<p>EVO™ Inverter/Charger is in <b>FAULT MODE</b> because the main Bidirectional Transformer in the EVO™ Inverter/Charger has overheated to 150°C</p> <ul style="list-style-type: none"> <li>• The Green LED marked "Status" will be switched OFF and the Red LED marked "Fault" will be steady ON. The buzzer in EVO™ Inverter/Charger will beep steady</li> <li>• If in Inverting Mode, Inverter Section will be switched OFF. If in Charging Mode, the Transfer Relay will be de-energized and the Inverter Section will be switched OFF.</li> <li>• Check that the fans are working properly, there is no blockage of air suction and discharge vents, adequate cool replacement air is available and the ambient temperature is within the limits. Reduce the load / "BULK CURRENT" (<i>Section 4.4.2.1</i>)</li> <li>• The fault will be cleared when the transformer has cooled down to 80°C</li> </ul>

## SECTION 7 | Fault Messages and Troubleshooting Guide

Srl. No	Fault Message	Symptoms and Troubleshooting
10	Heat sink over heat !	<p>EVO™ Inverter/Charger is in <b>FAULT MODE</b> because the internal heat sink in the EVO™ Inverter/Charger has overheated to 70°C</p> <ul style="list-style-type: none"> <li>The Green LED marked "Status" will be switched OFF and the Red LED marked "Fault" will be steady ON. The buzzer in EVO™ Inverter/Charger will beep steady</li> <li>If in Inverting Mode, Inverter Section will be switched OFF. If in Charging Mode, the Transfer Relay will be de-energized and the Inverter Section will be switched OFF.</li> <li>Check that the fans are working properly, there is no blockage of air suction and discharge vents, adequate cool replacement air is available and the ambient temperature is within the limits. Reduce the load and "BULK CURRENT" (<i>Section 4.4.2.1</i>)</li> <li>The fault will be cleared when the heat sink has cooled down to 40°C</li> </ul>
11	SD card unusable !	<ul style="list-style-type: none"> <li>Data logging will not start.</li> <li>Check that the format is FAT16/FAT32.</li> <li>Check that the capacity is less than 32 GB.</li> <li>Re-format the card.</li> </ul>
12	SD card read error !	<ul style="list-style-type: none"> <li>Data logging stops.</li> <li>Remove and re-insert the card.</li> </ul>
13	SD card write error !	<ul style="list-style-type: none"> <li>Data logging stops.</li> <li>Remove and re-insert the card.</li> </ul>
14	SD card full !	<ul style="list-style-type: none"> <li>Move or delete files or re-format the card.</li> </ul>
15	WRITE FAILURE !	<ul style="list-style-type: none"> <li>The entered value of programmable parameter could not be written. Call Technical Support.</li> </ul>
16	OUT OF RANGE !	<ul style="list-style-type: none"> <li>The entered value of programmable parameter is out of the programmable range. Change parameter value to within the specified range.</li> </ul>

## SECTION 8 | Specifications

### 8.1 SPECIFICATIONS

	MODEL NO.	EVO-RC
<b>COMPATIBLE INVERTER/CHARGERS</b>	MODEL NUMBERS	EVO-2212, EVO-3012, EVO-2224, EVO-4024 EVO-2212E, EVO-3012E, EVO-2224E, EVO-4024E
<b>DISPLAY</b>	LCD DISPLAY	2 Rows, 16 Character each, Alpha-Numeric LCD Display
	LED INDICATORS	Green (Status); Red (Fault / Alarm)
<b>INPUT / OUTPUT CONNECTION</b>	CABLE SET	RJ-45 Data Cable (Straight Wired); 10 Meters / 33 ft
<b>ENVIRONMENT</b>	OPERATING TEMPERATURE RANGE	-20°C to 60°C
<b>DIMENSIONS</b>	(W X H X D), MM	144 x 114 x 35.4
	(W X H X D), INCHES	5.6 x 4.5 x 1.4
<b>WEIGHT</b>	WEIGHT WITHOUT CABLE	0.2 kg / 0.4 lb
	WEIGHT WITH CABLES	0.5 kg / 1.2 lb

## **SECTION 9 | Warranty**

### **3 YEAR LIMITED WARRANTY**

EVO-RC manufactured by Samlex America Inc. (the “Warrantor”) is warranted to be free from defects in workmanship and materials under normal use and service. The warranty period is 3 years for the United States and Canada, and is in effect from the date of purchase by the user (the “Purchaser”).

Warranty outside of the United States and Canada is limited to 6 months. For a warranty claim, the Purchaser should contact the place of purchase to obtain a Return Authorization Number.

The defective part or unit should be returned at the Purchaser’s expense to the authorized location. A written statement describing the nature of the defect, the date of purchase, the place of purchase, and the Purchaser’s name, address and telephone number should also be included.

If upon the Warrantor’s examination, the defect proves to be the result of defective material or workmanship, the equipment will be repaired or replaced at the Warrantor’s option without charge, and returned to the Purchaser at the Warrantor’s expense. (Contiguous US and Canada only) using a carrier of the warrantor’s choice.

Warranty service shall be performed only by the Warrantor. Any attempt to remedy the defect by anyone other than the Warrantor shall render this warranty void. The warranty does not apply to units with a serial number that has been altered, removed or modified in any way.

There is no warranty for defects or damages to equipment or parts caused by:

- Installation, alternation, inspection or removal
- Normal wear and tear
- Abuse or misuse of the equipment including exposure to excessive heat, salt or fresh water spray, or water immersion
- Corrosion, fire, lightening, biological infestations or Acts of God
- Repairs attempted by anyone other than the Warrantor
- Improper use, contrary to operational instructions provided in product manual
- Shipping or transport

No other express warranty is hereby given and there are no warranties which extend beyond those described herein. This warranty is expressly in lieu of any other expressed or implied warranties, including any implied warranty of merchantability, fitness for the ordinary purposes for which such goods are used, or fitness for a particular purpose, or any other obligations on the part of the Warrantor or its employees and representatives.

There shall be no responsibility or liability whatsoever on the part of the Warrantor or its employees and representatives for injury to any persons, or damage to person or persons, or damage to property, or loss of income or profit, or any other consequential or resulting damage which may be claimed to have been incurred through the use or sale of the equipment, including any possible failure of malfunction of the equipment, or part thereof. The Warrantor assumes no liability for incidental or consequential damages of any kind.

**Samlex America Inc. (the “Warrantor”)**

**[www.samlexamerica.com](http://www.samlexamerica.com)**









# Contact Information

## Toll Free Numbers

Ph: 1 800 561 5885

Fax: 1 888 814 5210

## Local Numbers

Ph: 604 525 3836

Fax: 604 525 5221

## Website

[www.samlexamerica.com](http://www.samlexamerica.com)

## USA Shipping Warehouses

Kent, WA

Plymouth, MI

## Canadian Shipping Warehouse

Richmond, BC

Email purchase orders to  
[orders@samlexamerica.com](mailto:orders@samlexamerica.com)

